



operating instructions
bedieningshandleiding
manuel de l'utilisateur
bedienungsanweisung
istruzioni per l'uso
instuções de utilização
manuel de instrucciones
Çalıřtırma talimatları



easycheck



easycheck

Operating instructions

Contents

Introduction	
Overview	1
Display screen	4
Keypad	4
Connection	5
Safety precautions	6
Communication problems	6
Scan function - EOBD	
What is EOBD?	7
Identifying compliant vehicles	8
Diagnostic Trouble Codes	9
Interpreting EOBD fault codes	10
Using scan function	11
Menu options	13
FastCheck	
Introduction	16
Safety instructions	17
FastCheck ABS	19
FastCheck airbag	23
FastCheck climate	26
FastCheck EPB	29
FastCheck SAS	38
FastCheck service	42
Diagnostic connector locations	57
User menu	
Overview	67
Security	69
CAN Converter (Firmware update)	70
General information	
Cleaning	72
Software updates	72
Specification	73
Declaration of Conformity	73
Appendix A: Glossary	
Glossary of terms	74

Contents

Appendix B: Cables	
Cable identification.....	78
Appendix C: Manufacturer compatibility	
Scan function.....	82
FastCheck functions.....	82
Appendix D: Manual service reset	
Service Reminder Indicator (SRI).....	83
Alfa Romeo.....	83
Audi.....	84
BMW.....	85
Citroen.....	86
Fiat.....	93
GM Vauxhall/Opel.....	94
Lancia.....	95
Land Rover.....	96
Mercedes.....	97
Peugeot.....	98
Renault.....	104
Smart.....	109
Volkswagen.....	110
Volvo.....	111

Overview

Nearly every new road vehicle, and many older vehicles, have multiple control modules that monitor and control different aspects of the vehicle (e.g. Engine, Transmission, Body, Suspension, etc.). The TRW easycheck service tool has been specifically designed to connect to, and communicate with, a number of these control modules and allow the user to extract information (e.g. Diagnostic Trouble Codes) which may aid in the diagnosis of system problems.



OM0947

The functions available on the TRW easycheck service tool are dependent on the number of functions that have been purchased. Additional functions can be purchased separately. For further details, please contact the Product Support Team.

Scan

- The EOBD (European On-Board Diagnostic) Scan function allows you to access the vehicles emission related data through the OBD functionality. This includes MI (Malfunction Indicator) status, read and clear faults, live data, O2 sensor tests, freeze frame data and more.

Brakes

- FastCheck ABS allows you to read and clear any fault codes stored by the selected system.
- FastCheck EPB (Electronic Parking Brake) allows you to read and clear any fault codes stored by the selected system, and in addition can be used during brake operation checks or brake pad replacement.

SRS

- FastCheck Airbag allows you to read and clear any fault codes stored by the selected system.

Introduction

Climate

- FastCheck Climate allows you to read and clear any fault codes stored by the selected system.

SAS

- FastCheck SAS (Steering Angle Sensor) allows you to read and clear any fault codes stored by the selected system, and in addition can be used to calibrate the steering angle sensor.

Service

- FastCheck Service allows you to reset, dependant upon vehicle, the oil service interval indicator, service and inspection warning lights.

If you are using the service tool for the first time, it is recommended that you read these instructions and safety guidelines fully, prior to commencing any testing on a vehicle.

Getting started

Connect the EOBD cable (YTD950) to the service tool and the vehicle's diagnostic connector. Once connected, the current software version number is displayed.

Registration and unlocking of units.

A new or updated service tool requires a security key to unlock the specific functions. To register the service tool, log on to www.trwaftermarket.com/easycheck website and select the link to the administration centre.

If the automatic security key activation process is unsuccessful, make a note of the activation code as detailed on the web site and carry out the following procedure to manually unlock the required functions.

1. Select 'User Menu' from the main menu.
2. Select 'Security' from the user menu.
3. Select 'Enter Security Key' from the security menu.
4. Using the ▲ and ▼ keys, scroll through the alpha/numerical character list.
5. Confirm each character by pressing the ✓ key.

If you make a mistake use the ◀▶ key and enter the correct character. To re-enter the code from the beginning, press the ✕ key.

6. When prompted to verify the security key, press ✓ to confirm.
7. Power down the service tool by disconnecting the power source.
8. Reconnect the power supply to restart the service tool. The screen should now show a list of the functions included.

Further support can be obtained by calling 00800 2002 8282.

Kit contents

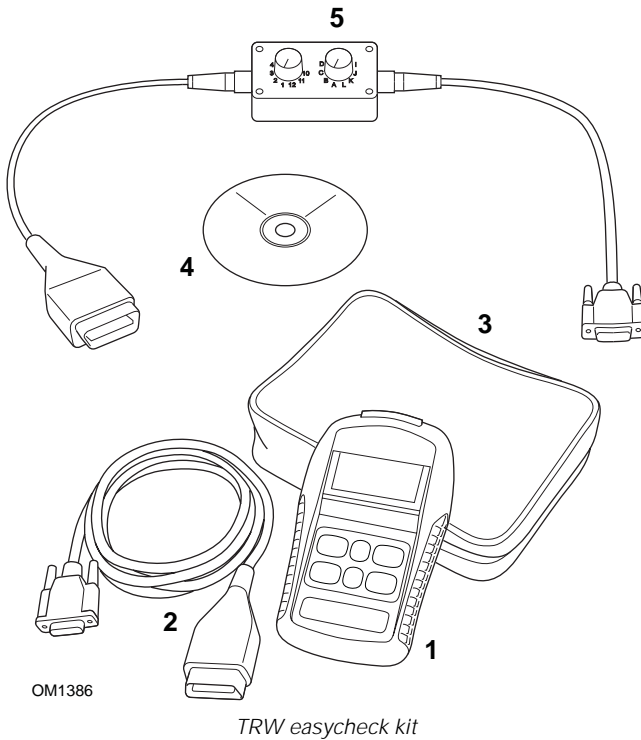

1. Service tool
2. EOBD cable
3. Carry case
4. CD ROM containing operating instructions
5. EOBD pin-switchable cable

Introduction

Display screen

The service tool screen is a backlit LCD capable of displaying four rows of text containing up to twenty characters.

Keypad



OM0041

The service tool is operated via the 6-button keypad.

The table below details the keypad buttons and their functionality.

Key	Function
✓	Select a menu option, Continue or Yes.
X	Exit a menu or No.
▲	Scroll up within a menu or text.
▼	Scroll down within a menu or text.
◀▶	Scroll left and right.
?	Provide context sensitive help (where available).

Connection

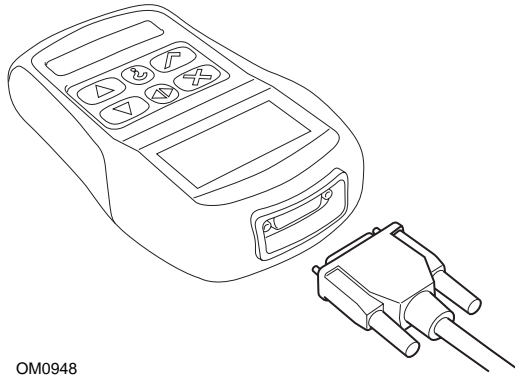

OM0948

The service tool has a 15-way connector through which it can communicate to the vehicle via various interface cables. Connection to the specific system is via either the vehicle's EOBD (J1962) diagnostic socket or by a system specific connector. Refer to the 'Vehicle Application List' to determine the correct cable.

When connecting the cable to the service tool, always secure the cable with the fixing screws to prevent accidental disconnection of the service tool during use.

Introduction

Safety precautions

The following guidelines are intended to ensure the safety of the operator whilst preventing damage to the electrical and electronic components fitted to the vehicle.

Equipment - prior to commencing any test procedure on the vehicle, ensure that the service tool, its harnesses and connectors are in good condition.

Polarity - always observe the correct polarity when connecting the service tool to the vehicle battery

Before carrying out testing on a vehicle, the following procedure should always be observed:

- Check the handbrake/parking brake is ON.
- Check that neutral or park is selected.
- Keep test equipment and harnesses away from HT leads.
- Be aware of moving engine parts.
- Do not run engine in a confined space without adequate ventilation.

Communication problems

If communications cannot be established with the vehicle, follow the procedure below:

1. Check the correct system was selected from the menu.
2. Check the correct cable was used against the application list.
3. Disconnect both ends of the cable and ensure that no pins are bent or snapped.
4. Reset the control module on the vehicle by turning the ignition OFF and ON, reconnect the service tool and try again.

If communications still cannot be established, contact the Product Support Team desk for further assistance.

What is EOBD?

The American Environmental Protection Agency and the European government have set targets for reducing the levels of pollution produced by passenger and commercial vehicles. In order to ensure that these targets can be met, manufacturers are required to build new vehicles which meet increasingly stiff emissions standards. The manufacturers must further maintain these emission standards for the useful life of the vehicle. In order to meet and maintain these standards the vehicles are fitted with On-Board Diagnostic systems which monitor the integrity and effectiveness of all emission related components.

As vehicles are becoming more and more complex, many of the systems fitted to them are being controlled by electronic control modules. Most vehicles now have multiple control modules (e.g. Engine, Transmission, Body, Suspension, etc.) located at different locations on the vehicle. The On-Board Diagnostic systems are integrated into the vehicle control modules.

With so many different vehicle and component manufacturers, a common interface was required to communicate with these control modules. In 1988, the SAE (Society of Automotive Engineers) created a standard that defined a standard diagnostic socket (J1962) and a set of diagnostic test signals.

With the diagnostic socket and diagnostic signals agreed, another standard was produced that defined a universal inspection and diagnosis method to ensure that a vehicle is performing to Original Equipment Manufacturer (OEM) specifications. This standard is known as EOBD (European On-Board Diagnostics).

The fundamental requirement for an EOBD system is that in the event of an emissions related component fault, a DTC (Diagnostic Trouble Code) will be stored in the memory of the control module responsible for that component, and a Malfunction Indicator Lamp (MIL) will illuminate on the vehicle's instrument pack to alert the driver. The DTC can then be retrieved using diagnostic equipment to determine the type and status of the fault.

Scan function - EOBD

Identifying compliant vehicles

All petrol engine vehicles manufactured since 2000 should be EOBD compliant. Some manufacturers began incorporating On-Board Diagnostic systems as early as 1994, however not all are 100% compliant. All diesel engine vehicles are expected to have support from 2004. This means that diagnostic information, related to vehicle emissions, may be extracted from the vehicle via the J1962 diagnostic socket using the service tool.

The service tool can communicate with any EOBD compliant vehicle using one of the five diagnostic communication protocols defined in the standard.

These are

- ISO 9141.
- Keyword 2000 (originally a European protocol).
- J1850 PWM (pulse width modulated) protocol used by Ford.
- J1850 VPW (variable pulse width modulated) used by General Motors in USA designed vehicles.
- CAN (controller area network) currently being legislated for and likely to be a principle diagnostic communication system in the future. A European protocol.

It is normally possible to tell which is used on a specific vehicle by examining the diagnostic socket (as below), however the service tool's software will automatically detect the protocol used on the vehicle to which it is connected.

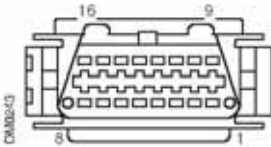

- If the diagnostic socket has a pin in the '7' or '15' position, then the vehicle uses either the ISO 9141 or Keyword 2000 protocol.
- If the diagnostic socket has a pin in the '2' or '10' position, then the vehicle uses one of the SAE J1850 protocols.
- If the diagnostic socket has a pin in the '6' or '14' position, then the vehicle uses the CAN protocol.

NOTE: Although there are different EOBD electrical connection protocols, the command set is fixed according to the SAE J1979 standard.

Diagnostic Trouble Codes

Diagnostic Trouble Codes (DTCs) are divided into mandatory and voluntary codes. Mandatory codes are allocated by the ISO (International Standards Organisation) / SAE (Society of Automotive Engineers). Voluntary codes are allocated by various vehicle manufacturers and are manufacturer specific and in some instances, vehicle specific.

ISO/SAE controlled diagnostic trouble codes are those codes where industry uniformity has been achieved. These codes were felt to be common enough across most manufacturer's applications that a common number and fault message could be assigned. All unspecified numbers in each grouping have been reserved for future growth. Although service procedures may differ widely amongst manufacturers, the fault being indicated is common enough to be assigned a particular fault code. Codes in this area are not to be used by manufacturers until they have been approved by ISO/SAE.

Areas within each of the fault code blocks have been allocated for manufacturer controlled DTCs. These are fault codes that will not generally be used by the majority of the manufacturers due to basic system differences, implementation differences, or diagnostic strategy differences.

Scan function - EOBD

Interpreting EOBD fault codes

Use the following rules to determine the basic meaning of an EOBD fault code.

P	Powertrain
B	Body
C	Chassis
U	Network

The first character indicates which area of the vehicle the code applies to.

0	Standard (SAE) code
1	Manufacturer's own code

The second character specifies the type of code:

1	Fuel and air metering
2	Fuel and air metering, specifically injector circuit
3	Ignition system and misfire detection
4	Auxiliary emission controls
5	Vehicle speed control and idle control system
6	Computer output circuit
7	Transmission related faults
8	Transmission related faults

If the first character was 'P' (Powertrain) then the third character identifies the specific Powertrain system concerned:

The last two characters identify the specific fault as seen by the on-board systems.

Using scan function

Connection and basic operation

1. Connect the EOBD (J1962) cable (YTD950) to the service tool and secure the fixing screws.
2. Ensure the vehicle's ignition switch is in the '0' (fully OFF) position.

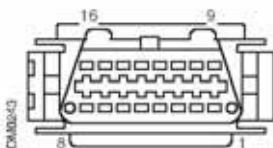

J1962 Diagnostic socket

3. Connect the service tool to the vehicle via the J1962 diagnostic socket. This socket is usually located inside the passenger compartment in the vicinity of the driver's footwell. Refer to vehicle manufacturer's information for the exact location.

Power for the service tool is provided by the diagnostic socket. When connected to the diagnostic socket, the service tool will perform an internal self test and then the screen will display the date of the current software version before displaying the main menu.

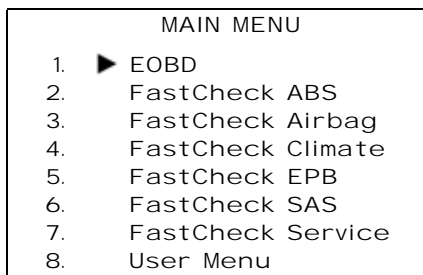

4. Use the ▲ and ▼ keys to select the EOBD menu function. Press ✓ to confirm the selection.
5. Turn the ignition ON when prompted, then press the ✓ key to confirm. The service tool will then attempt to establish communication with the vehicle's On-Board Diagnostics.

A screenshot of the service tool's display showing the text: 'Establishing Data Link with Vehicle CMs - Please Wait.....'. The text is centered on the screen.

Scan function - EOBD

- 6. If the vehicle system is not EOBD compliant or there is a connection problem, the "Please Wait" screen will be replaced with help screens.

If communication with the On-Board Diagnostics is successful, then the display will report that the service tool is checking the vehicle's 'System Readiness' tests.

NOTE: The vehicle's ignition MUST be ON for successful communication with the vehicle control modules.

- 7. The service tool checks to see which of the 'System Readiness' tests have been run and successfully completed and then the screen will inform you of the status. Press the ✓ key to continue.

NOTE: The service tool will always check the status of the 'System Readiness' tests before displaying the EOBD Operations menu.

- 8. The screen will then give you the option of viewing the status of the tests performed on the emission related systems and their components.

Press the ✓ key to display the results.

Press the ✕ key to bypass the results and go to the EOBD Operations menu.

EOBD OPERATIONS	
1.	MI Status
2.	View DTCs
3.	Erase DTCs
4.	Live Data
5.	O2 Sensor Tests
6.	View Freeze Frame
7.	Non-Continuous
8.	Continuous Tests
9.	System Control
10.	Vehicle Info
11.	OBD Status
12.	System Readiness
13.	General Info
14.	Tester Setup

- 9. Use the ▲ and ▼ keys to select the required function and press ✓ to confirm the selection.

Easy reset facility

To reset the service tool without disconnecting from the vehicle, hold down the ✕, ✓, ▲ & ▼ keys simultaneously.

Menu options

Not all vehicle control modules will support all of the options available from the menu. If an option is not supported the service tool will display either " Not Supported" or " Not Available" . This is a limitation of the software on the vehicle control modules and **NOT** a fault with the service tool.

MI Status/MIL Status

'MI Status' or 'MIL Status' displays the status of the malfunction indicator lamp for each emissions related control module. If the status of the MIL is set to ON, one or more DTCs will be stored in the vehicle's control modules and the instrument panel MIL will be illuminated.

View DTCs

This option allows any 'Stored' or 'Continuous' emission related DTCs (Diagnostic Trouble Codes) to be viewed. If any DTC is present, it will be displayed along with the identity of the Control Module (CM) that registered the fault.

If more than one DTC is displayed, the required DTC can be selected by using the ▲ and ▼ keys. Press ✓ to select the DTC and display the description of the code.

Dependant upon the DTC and the vehicle manufacturer, it may be necessary to select the manufacturer and possibly also the model of the vehicle to enable the correct description to be displayed. This setting will be retained while the service tool is being used for EOBD operations but can be redefined or cleared under the 'Manufacturer' menu option.

Erase DTCs

This option will clear **all** 'Stored' and 'Continuous' emission related DTCs, clear 'Freeze Frame' DTCs and associated data, clear 'O2 Sensor Test' data, clear 'Non-Continuous' test results and reset the status of the 'System Readiness' tests on the control modules on the vehicle. The service tool will then perform a 'Read DTCs' operation to verify that the DTCs have been erased.

Live Data

This option allows the user to view the current status of the emission system components on the vehicle and can provide a quick way of telling if a component is working correctly.

The list of components monitored under 'Live Data' can vary between manufacturers and even between model.

Scan function - EOBD

O2 Sensor Tests

EOBD has an optional mode for monitoring the oxygen sensor test results depending on the method used by the vehicle manufacturer to comply with the requirement for oxygen sensor monitoring. If the manufacturer does use this mode not all tests need to be supported. The service tool will display the supported tests and the data associated with those tests e.g. Maximum sensor voltage for a test cycle (calculated).

View Freeze Frame

Freeze frame data is a snap-shot of live data that was stored in the control module at the moment a Diagnostic Trouble Code was recognised. If a number of faults occurred, then the freeze frame data stored is associated with the last fault to occur. The DTC that generated the freeze frame data is also displayed in the data.

Non-Continuous

Some vehicle systems are not monitored continuously during normal running conditions, e.g. catalysts and evaporative systems. These tests are manufacturer specific, so while the results of the test will be shown, the meaning of the results cannot.

Continuous Tests (Pending Codes)

When the 'continuous monitor' detects a failure condition in an emission-related powertrain component or system, only once in a drive cycle, it stores a 'Continuous' code in the control module's memory. If the continuous monitor detects the same failure condition during the next drive cycle, it registers a DTC and illuminates the MI.

System Control

Components on the vehicle may be turned on and off, or pulsed to test their operation. These tests are manufacturer specific and are currently seldom supported in controllers.

Vehicle Info

Information is displayed relating to the vehicle. This may be the VIN, controller version numbers etc., but is not supported by all vehicles.

OBD Status

Indicates to the user whether or not the controller supports OBD requirements. Not all vehicles support this.

System Readiness

When the ignition is turned ON the vehicle's control modules perform a number of tests on the system ('System Readiness' tests). If the conditions are not correct for the controller to perform the test e.g. if the engine is too cold, "Not Ready" status will be reported. Readiness test status is also offered for inspection after communications have been established. These may be reviewed or ignored until later.

The service tool allows the user to do continual reads of the status of the System Readiness tests i.e. whether the test is not supported, waiting to complete or has completed. This status can help a technician verify a repair by checking that the readiness tests that may have generated a DTC have run to completion. The following sub menu will let the user display the results in two ways.

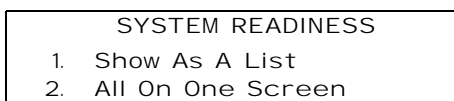

The option 'Show as a List' will give the user the options of 'DTCs Last Cleared' and 'Current Drive Cycle'. The selection 'DTCs Last Cleared' is normally found on all EOBD vehicles and shows the status since the last clearing of DTCs, but it may not be valid for the current drive cycle. The option 'Current Drive Cycle' will display the status of the tests for the current drive cycle, but this is rarely supported on vehicles at this time.

The option 'All On One Screen' will show an abbreviated text version of the status for all the tests since 'DTCs Last Cleared'.

In both cases the service tool is continually updating the status displayed for each test.

Tester Setup

This allows the user to select the units displayed in 'Live Data' and 'Freeze Frame' from either metric or imperial. The user may also select from abbreviated text or full text phrases. For more information, see '*Diagnostic connector locations*', page 56.

FastCheck

Introduction

The 'FastCheck' functions allow the service tool to communicate with other system control modules on the vehicle.

Connection to the specific system is via either the vehicle's EOBD (J1962) diagnostic socket or by a system specific connector. Refer to the 'Vehicle Application List' to determine the correct cable.

Brake

- 'FastCheck ABS' allows you to read and clear any fault codes stored by the selected system.
- 'FastCheck EPB' (Electronic Parking Brake) allows you to read and clear any fault codes stored by the selected system, and in addition can be used during brake operation checks or brake pad replacement.

SRS

- 'FastCheck Airbag' allows you to read and clear any fault codes stored by the selected system.

Climate

- 'FastCheck Climate' allows you to read and clear any fault codes stored by the selected system.

SAS

- 'FastCheck SAS' (Steering Angle Sensor) allows you to read and clear any fault codes stored by the selected system, and in addition can be used to calibrate the steering angle sensor.

Service

- 'FastCheck Service' allows you to reset, dependant upon vehicle, the oil service interval indicator, service and inspection warning lights.

Safety instructions

WARNING: General safety

- *All operations must be carried out in a well ventilated area away from open flame and heat sources.*
- *Ensure the vehicle is stationary and the handbrake (parking brake) is applied before carrying out any maintenance/diagnostic work.*

WARNING: Air conditioning safety

- *Servicing must only be carried out if you are familiar with both the vehicle system and the test equipment.*
- *Air conditioning refrigerant is a hazardous liquid and when handled incorrectly can cause serious injury. Suitable protective clothing, consisting of face protection, heat proof gloves, rubber boots and rubber apron or waterproof overalls, must be worn when carrying out operations on the air conditioning system.*
- *Danger of asphyxiation, refrigerant gas is heavier than air and will collect in vehicle inspection pits or confined spaces, always recover all refrigerant from a damaged system before commencing work.*

WARNING: Airbag safety

- *All work on vehicle restraint systems should be carried out by trained personnel. NEVER install accessories in the vicinity of driver, passenger or side airbags.*
- *Observe component manufacturers instructions for safety, handling and installation of components.*
- *Airbags are classed as explosive devices and as such are subject to national laws which must be followed. This includes storage and transportation.*
- *ALWAYS store removed airbags in a secure area away from other hazardous materials.*
- *DO NOT connect or disconnect any wiring with the ignition ON. ALWAYS turn the ignition switch to the 'OFF' position and allow at least 1 minute for the system to discharge.*
- *NEVER expose system components to temperatures above 176°F (80°C).*
- *ONLY use approved diagnostic testers to diagnose faults, NEVER use multi-meters or test lamps etc.*
- *ALWAYS disconnect all airbags and seat belt pre-tensioners before using a multi-meter to check the wiring.*

WARNING: Electronic Parking Brake (EPB) safety

- ***Ensure that you are fully familiar with the braking system and its operation before commencing any work.***
- ***The EPB control system may be required to be deactivated before carrying out any maintenance/diagnostic work on the brake system. This can be done from the service tool menu.***
- ***Only carry out maintenance work when the vehicle is stationary and on level ground.***
- ***Ensure that the EPB control system is reactivated after the maintenance work has been completed.***

NOTE: TRW accept no responsibility for any accident or injury arising from the maintenance of the Electronic Parking Brake system.

FastCheck ABS

Important information

Mercedes vehicles with Sensotronic Brake Control

- Ensure that you are fully familiar with the braking system and its operation before commencing any work.
- The Sensotronic Brake Control system must be deactivated before carrying out any maintenance/diagnostic work on the brake system. This can be done from the service tool menu.
- Only commence work after the system has been deactivated. Upon deactivation, a warning message should appear in the instrument panel accompanied by an audible warning signal until the system is reactivated. If the warning signals do not occur, assume that the system is not fully deactivated and DO NOT commence work.
- Ensure that the Sensotronic Brake Control system is reactivated after the maintenance work has been completed.

NOTE: The manufacturer of the service tool accept no responsibility for any accident or injury arising from the maintenance of the Sensotronic Brake Control system.

Connection

Using the Vehicle Application List on the CD-ROM, identify the required interface cable for the vehicle system to be tested. Connect the cable to the service tool and secure the fixing screws.

NOTE: If the vehicle being tested is a BMW with a 20 pin connector and an EOBD (J1962) connector, you must only use the 20 pin connector.

NOTE: The CAN converter (YTD960) harness must be used for any diagnostics on the following vehicles:

BMW 1 series (E81/E87)

BMW 3 series (E90/E91/E92/E93)

BMW 5 series (E60/E61)

BMW 6 series (E63/E64)

BMW 7 series (E65)

GM Opel/Vauxhall - Corsa D

GM Opel/Vauxhall - Signum

GM Opel/Vauxhall - Vectra C

GM Opel/Vauxhall - Zafira B

FastCheck

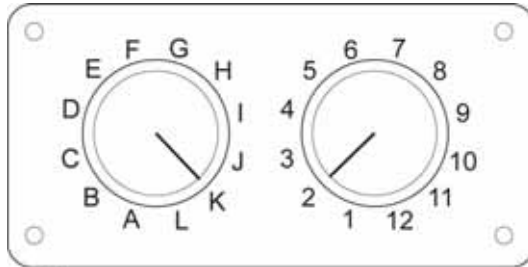

OM0957

If using the EOBD (J1962) pin-switchable cable (YTD951), ensure the settings on the switch box correspond to the settings listed for the vehicle and system being tested.

WARNING: Incorrect settings on the switch box may cause irreparable damage to the vehicle's electrical system.

Ensure the vehicle's ignition is OFF.

Connect the service tool to the required vehicle connector, refer to 'Diagnostic connector locations', page 56, for further information.

Power for the service tool is provided by the vehicle connector. Once connected, the service tool will perform an internal self test and then the screen will display the version of the current software before displaying the main menu.

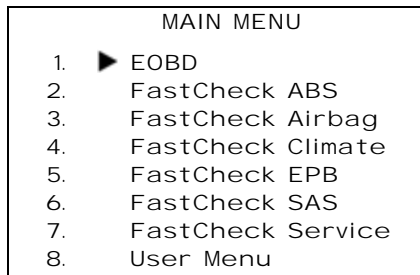

Use the ▲ and ▼ keys to select the 'FastCheck ABS' function and press ✓ to confirm the selection. To return to the previous menu, press the ✕ key.

Turn the vehicle's ignition ON.

Use the ▲ and ▼ keys to select the vehicle manufacturer and press ✓ to confirm the selection.

Dependant upon the vehicle and function being run, you may be asked to choose the particular system fitted to the vehicle. Select the correct system using the ▲ and ▼ keys and press ✓ to confirm.

1. Read DTCs
2. Clear DTCs

Select the required menu option using the ▲ and ▼ keys and press ✓ to confirm.

The service tool will attempt to establish communication with the vehicle system. If communication is unsuccessful, refer to '*Communication problems*', page 6.

Read DTCs

If any DTC codes are present in the system, a screen will be displayed informing you how many codes were found. This will then be replaced by the first DTC code. DTC codes are generated according to the vehicle and system manufacturer.

```
DTC 1 - 38 Right Low
Pressure Sensor
Circuit Signal High{ }
```

A typical DTC code

The fault number is displayed first, followed by the DTC code. In this example the fault displayed is DTC number 38 - Right Low Pressure Sensor Circuit Signal High or Open Circuit. If the description text is too long to fit on the display, '(...)' appears in the bottom right corner of the screen. This indicates that the text can be scrolled using the ▲ and ▼ keys to view the rest of the description.

To view the next DTC (if more than 1 was found), scroll to the end of the text and press the ✓ key.

To return to the menu, scroll to the end of the text and press the ✕ key.

Clear DTCs

Diagnostic trouble codes can be cleared using the 'Clear DTCs' option. When using the option you will be prompted to turn the ignition off. Wait until prompted before switching the ignition back on.

Start the engine to force the control module to run a system check. Verify that the code(s) have been cleared by selecting 'Read DTCs'.

NOTE: Reading DTC(s) without first starting the engine will only confirm that the stored DTC(s) have been cleared. Faults may still be present in the system causing a DTC to be stored next time the engine is started.

FastCheck

BMW vehicles

NOTE: To switch the ignition ON for vehicles fitted with a start/stop button, insert the remote key-fob fully into the ignition slot then press the start/stop button once (without any foot pedals depressed).

BMW	
1.	Read DTCs
2.	Clear DTCs
3.	Select System

Use the ▲ and ▼ keys to select the required menu option and press ✓ to confirm the selection. To return to a previous menu, press the ✕ key.

If you know the system you require:

1. Select 'Select System' from the BMW menu.
2. Select the required system (e.g. ABS/DSC2). The service tool then returns to the BMW menu.
3. Select 'Read DTCs' or 'Clear DTCs'.
4. The service tool will attempt to communicate with the system selected and will display the relevant faults list.

FastCheck airbag

Connection

Using the Vehicle Application List on the CD-ROM, identify the required interface cable for the vehicle system to be tested. Connect the cable to the service tool and secure the fixing screws.

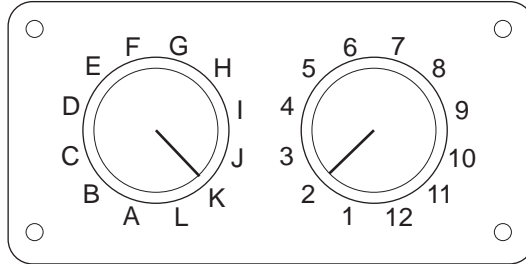

OM0957

If using the EOBD (J1962) pin-switchable cable (YTD951), ensure the settings on the switch box correspond to the settings listed for the vehicle and system being tested.

WARNING: Incorrect settings on the switch box may cause irreparable damage to the vehicle's electrical system.

NOTE: The CAN converter (YTD960) harness must be used for any diagnostics on the following vehicles:

BMW 1 series (E81/E87)

BMW 3 series (E90/E91/E92/E93)

BMW 5 series (E60/E61)

BMW 6 series (E63/E64)

BMW 7 series (E65)

GM Opel/Vauxhall - Corsa D

GM Opel/Vauxhall - Signum

GM Opel/Vauxhall - Vectra C

GM Opel/Vauxhall - Zafira B

Ensure the vehicle's ignition is OFF.

Connect the service tool to the required vehicle connector, refer to 'Diagnostic connector locations', page 56, for further information.

Power for the service tool is provided by the vehicle connector. Once connected, the service tool will perform an internal self test and then the screen will display the version of the current software before displaying the main menu.

FastCheck

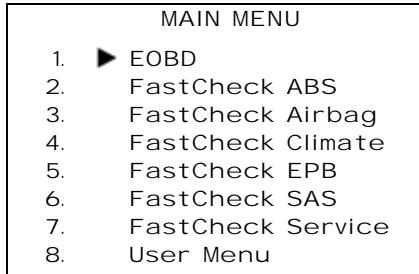

Use the ▲ and ▼ keys to select the 'FastCheck Airbag' function and press ✓ to confirm the selection. To return to the previous menu, press the ✕ key.

Turn the vehicle's ignition ON.

Use the ▲ and ▼ keys to select the vehicle manufacturer and press ✓ to confirm the selection.

Dependant upon the vehicle and function being run, you may be asked to choose the particular system fitted to the vehicle. Select the correct system using the ▲ and ▼ keys and press ✓ to confirm.

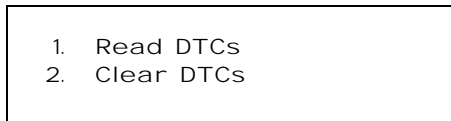

Select the required menu option using the ▲ and ▼ keys and press ✓ to confirm.

The service tool will attempt to establish communication with the vehicle system. If communication is unsuccessful, refer to '*Communication problems*', page 6.

Read DTCs

If any DTC codes are present in the system, a screen will be displayed informing you how many codes were found. This will then be replaced by the first DTC code. DTC codes are generated according to the vehicle and system manufacturer.

The fault number is displayed first, followed by the DTC code. If the description text is too long to fit on the display, '(...)' appears in the bottom right corner of the screen. This indicates that the text can be scrolled using the ▲ and ▼ keys to view the rest of the description.

To view the next DTC (if more than 1 was found), scroll to the end of the text and press the ✓ key.

To return to the menu, scroll to the end of the text and press the ✕ key.

Clear DTCs

Diagnostic trouble codes can be cleared using the 'Clear DTCs' option. When using the option you will be prompted to turn the ignition OFF. Wait until prompted before switching the ignition back ON.

Verify that the code(s) have been cleared by selecting 'Read DTCs'.

BMW vehicles

NOTE: To switch the ignition ON for vehicles fitted with a start/stop button, insert the remote key-fob fully into the ignition slot then press the start/stop button once (without any foot pedals depressed).

Some BMW vehicles are equipped with multiple airbag systems, one for each airbag fitted to the vehicle.

Applicable Vehicles:

BMW 3 series (E90/E91/E92/E93)

BMW 5 series (E60/E61)

BMW 6 series (E63/E64)

BMW 7 series (E65)

BMW Z4 (E85)

If on selecting the Read DTCs or Clear DTCs and a multiple airbag system is detected, then a menu containing a list of airbag systems fitted to the vehicle will be displayed.

Use the ▲ and ▼ keys to select the required system from the menu shown. Press the ✓ key to select the system required the Read DTCs or Clear DTCs will be performed. Press the ✕ key while the system menu is displayed to return back to the Read DTCs and Clear DTCs menu.

All airbag ECU's

If the All airbag ECU's was selected then the Read DTCs or Clear DTCs function will be performed on **ALL** detected airbag systems on the vehicle.

FastCheck climate

Connection

Using the Vehicle Application List on the CD-ROM, identify the required interface cable for the vehicle system to be tested. Connect the cable to the service tool and secure the fixing screws.

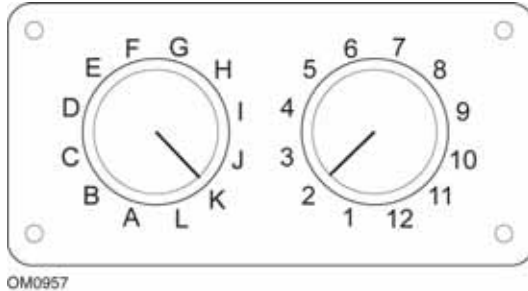

If using the EOBD (J1962) pin-switchable cable (YTD951), ensure the settings on the switch box correspond to the settings listed for the vehicle and system being tested.

WARNING: Incorrect settings on the switch box may cause irreparable damage to the vehicle's electrical system.

NOTE: The CAN converter (YTD960) harness must be used for any diagnostics on the following vehicles:

BMW 1 series (E81/E87)

BMW 3 series (E90/E91/E92/E93)

BMW 5 series (E60/E61)

BMW 6 series (E63/E64)

BMW 7 series (E65)

GM Opel/Vauxhall - Corsa D

GM Opel/Vauxhall - Signum

GM Opel/Vauxhall - Vectra C

GM Opel/Vauxhall - Zafira B

Ensure the vehicle's ignition is OFF.

Connect the service tool to the required vehicle connector, refer to 'Diagnostic connector locations', page 56, for further information.

Power for the service tool is provided by the vehicle connector. Once connected, the service tool will perform an internal self test and then the screen will display the version of the current software before displaying the main menu.

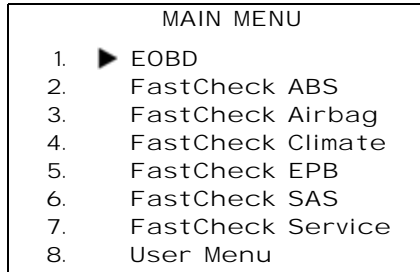

Use the ▲ and ▼ keys to select the 'FastCheck Climate' function and press ✓ to confirm the selection. To return to the previous menu, press the ✕ key.

Turn the vehicle's ignition ON.

Use the ▲ and ▼ keys to select the vehicle manufacturer and press ✓ to confirm the selection.

Dependant upon the vehicle and function being run, you may be asked to choose the particular system fitted to the vehicle. Select the correct system using the ▲ and ▼ keys and press ✓ to confirm.

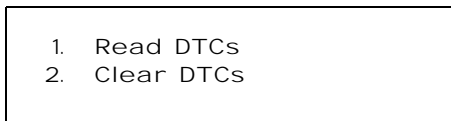

Select the required menu option using the ▲ and ▼ keys and press ✓ to confirm.

The service tool will attempt to establish communication with the vehicle system. If communication is unsuccessful, refer to '*Communication problems*', page 6.

Read DTCs

If any DTC codes are present in the system, a screen will be displayed informing you how many codes were found. This will then be replaced by the first DTC code. DTC codes are generated according to the vehicle and system manufacturer.

The fault number is displayed first, followed by the DTC code. If the description text is too long to fit on the display, '(...)' appears in the bottom right corner of the screen. This indicates that the text can be scrolled using the ▲ and ▼ keys to view the rest of the description.

To view the next DTC (if more than 1 was found), scroll to the end of the text and press the ✓ key.

FastCheck

To return to the menu, scroll to the end of the text and press the **x** key.

Clear DTCs

Diagnostic trouble codes can be cleared using the 'Clear DTCs' option. When using the option you will be prompted to turn the ignition OFF. Wait until prompted before switching the ignition back ON.

Start the engine to force the control module to run a system check. Verify that the code(s) have been cleared by selecting 'Read DTCs'.

NOTE: Reading DTC(s) without first starting the engine will only confirm that the stored DTC(s) have been cleared. Faults may still be present in the system causing a DTC to be stored next time the engine is started.

BMW vehicles

NOTE: To switch the ignition ON for vehicles fitted with a start/stop button, insert the remote key-fob fully into the ignition slot then press the start/stop button once (without any foot pedals depressed).

FastCheck EPB

Important information

Mercedes vehicles with Sensotronic Brake Control

- Ensure that you are fully familiar with the braking system and its operation before commencing any work.
- The Sensotronic Brake Control system must be deactivated before carrying out any maintenance/diagnostic work on the brake system. This can be done from the service tool menu.
- Only commence work after the system has been deactivated. Upon deactivation, a warning message should appear in the instrument panel accompanied by an audible warning signal until the system is reactivated. If the warning signals do not occur, assume that the system is not fully deactivated and DO NOT commence work.
- Ensure that the Sensotronic Brake Control system is reactivated after the maintenance work has been completed.

NOTE: The manufacturer of the service tool accept no responsibility for any accident or injury arising from the maintenance of the Sensotronic Brake Control system.

Connection

Using the Vehicle Application List, identify the required interface cable for the vehicle system to be tested. Connect the cable to the service tool and secure the fixing screws.

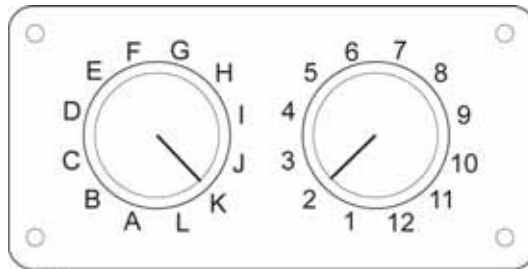

If using the EOBD (J1962) pin-switchable cable (YTD951), ensure the settings on the switch box correspond to the settings listed for the vehicle and system being tested.

WARNING: Incorrect settings on the switch box may cause irreparable damage to the vehicle's electrical system.

Ensure the vehicle's ignition is OFF.

Connect the service tool to the required vehicle connector, refer to 'Diagnostic connector locations', page 56, for further information.

FastCheck

Power for the service tool is provided by the vehicle connector. Once connected, the service tool will perform an internal self test and then the screen will display the version of the current software before displaying the main menu.

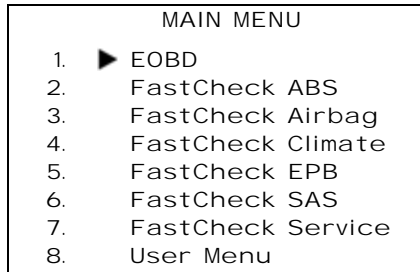

Use the ▲ and ▼ keys to select the 'FastCheck EPB' function and press ✓ to confirm the selection. To return to the previous menu, press the ✕ key.

Turn the vehicle's ignition ON.

Use the ▲ and ▼ keys to select the vehicle manufacturer and press ✓ to confirm the selection.

Dependant upon the vehicle manufacturer and model different menu options will then be available. Functions such as 'Read and Clear DTCs' will be available along with service functions.

Ford – Electronic Parking Brake (EPB) system

Two Electronic Parking Brake systems are currently supported on the service tool:

Ford Focus C-Max 2003 - present:

There are two test functions available under the calibration section of the EPB menu these are described below.

Electronic Parking Brake (EPB) calibration function test

Checks the EPB is working correctly. This test should be performed after work has been completed on the EPB or vehicle's braking system.

The test removes any air gap from the brake pads and checks the EPB pressure.

Pre-Test conditions:

- The vehicle must be stationary
- The vehicle must be on level ground
- The brake fluid level is correct

The operator will be asked to perform a number of actions before applying the EPB. The service tool reads and displays the EPB pressure. With the EPB applied the EPB pressure should be approximately 1100 Newton's.

The operator will then be asked to unlock/release the EPB. The service tool reads and displays the EPB pressure. With the EPB released the EPB pressure should be 0 Newton's.

If either of the above tests fail (pressure reading not correct) the EPB assembly should be removed and re-assembled.

Electronic Parking Brake (EPB) emergency release calibration

Checks the EPB emergency release is working correctly. This test should be performed after work has been completed on the EPB or vehicles braking system.

Pre-test conditions:

- The vehicle must be stationary
- The vehicle must be on level ground
- The brake fluid level is correct

The operator will be asked to perform a number of actions before applying the EPB. The service tool reads and displays the EPB pressure. With the EPB applied the EPB pressure should be approximately 1100 Newton's.

The operator will then be prompted to pull manually on the emergency release. The service tool reads and displays the EPB pressure. With the emergency release activated the EPB pressure should be 0 Newton's and the vehicle should be able to move freely.

If either of the above tests fail then the EPB assembly should be inspected and repaired as described by the manufacturer's instructions.

Ford S-Max 2006 - present:

There are four functions available under the 'Service Brakes' section of the PBM/EPB menu:

Enter Maintenance Mode

This function is used to put the system into a state that enables work to be carried out by the technician

The Control Module puts the calipers into a state where normal operation is inhibited and the callipers can not be closed by any means.

This function must be used if replacement of the brakes, discs or brake pads is to be carried out.

Pre-Test conditions:

- The vehicle must be stationary
- The vehicle must be on level ground
- The vehicle must be secured with wheel locks.

FastCheck

NOTE: After this function has been performed the EPB calipers can not be closed and are inhibited until exit maintenance mode is run. Cycling the ignition, disconnecting the battery or diagnostics tester does not exit maintenance mode.

Ensure the on screen instructions on the service tool are followed precisely and in the correct order.

Exit Maintenance Mode

This function is used to put the system back into an operational state after work has been carried out by the technician.

Calipers are closed to the applied position, and normal operation is available again.

Pre-Test conditions:

- The vehicle must be stationary
- The vehicle must be on level ground
- The vehicle must be secured with wheel locks.

This function also automatically performs an 'Assembly Check', which carries out internal tests on the Parking Brake system and reports the status (see below).

Ensure the on screen instructions on the service tool are followed precisely and in the correct order.

Assembly Check

This function is used to check the operation of the parking brake system after any work has been completed on the system.

Pre-Test conditions:

- The vehicle must be stationary
- The vehicle must be on level ground
- The vehicle must be secured with wheel locks.

Three internal tests are performed, each will report the status. If any of these tests fail then perform the Read DTCs function to detect the possible fault with the system.

NOTE: This test is automatically run as part of the 'Exit Maintenance Mode' function. It is not necessary to perform this function if the 'Exit Maintenance Mode' function reported no problems

NOTE: This function can not be performed while the parking brake system is in maintenance mode. It should only be performed when the system is in normal operating mode.

Ensure the on screen instructions on the service tool are followed precisely and in the correct order.

Static Apply

This function is used to test the operation of the actuators which operate the calipers.

This function closes the actuators to the nominal parking brake apply position.

Pre-Test conditions:

- The vehicle must be stationary
- The vehicle must be on level ground
- The vehicle must be secured with wheel locks.

It should be used if it is suspected that there is a fault with the Control Module, wiring, or the actuators (if the parking brake will not engage/disengage when manually operated).

NOTE: This function can not be performed while the parking brake system is in maintenance mode. It should only be performed when the system is in normal operating mode.

Ensure the on screen instructions on the service tool are followed precisely and in the correct order.

Notes on Use of functions

The four functions are designed to be used in several different situations. Here are few situations which may occur and the correct use of the functions to rectify the situation:

Rear Brake Pad, Brake Disc or Caliper Replacement:

1. If the vehicle requires any of the above components to be replaced the 'Enter Maintenance Mode' function should be performed.
2. The system will be disabled to allow maintenance work to be carried out easily and safely.
3. After the work has been carried out the 'Exit Maintenance Mode' function should be performed.

Any other EPB system component has been replaced:

1. DTCs should be read and cleared.
2. The 'Assembly Check' function should be performed to check the operation of the parking brake system.
3. If the 'Assembly Check' function fails, DTCs should be read again and the problem investigated.

The Parking Brake will not engage when manually operated via the button:

1. Ensure that the system is NOT in 'Maintenance Mode'. If it is then perform the 'Exit Maintenance Mode' function.

FastCheck

2. Read DTCs, there may be a DTC stored which will indicate the area of the fault.
3. Clear DTCs, there may be an intermittent fault on the system which needs to be cleared.
4. Perform the 'Static Apply' function. This will send a command directly to the Control Module which will then close the actuators to the nominal 'engaged' position.
5. Check the switch/button.
6. Check the actuators themselves or the wiring from the 'Control Module' to the actuators.

Renault - handbrake

There are test functions available under the circuit tests section of the 'Handbrake Menu' these are described below.

Release brakes

Pre-test conditions:

- The vehicle must be stationary
- The vehicle must be on level ground
- The engine must not be running

At the end of the test the handbrake will be released. The 'Apply Brakes' function should then be performed.

Apply brakes

Pre-test conditions:

- The vehicle must be stationary
- The vehicle must be on level ground
- The engine must not be running

The test requests the handbrake be applied during this test.

VAG – Electro-mechanic Parking Brake (EPB) system

VW/Audi EPB system integrates two electro-mechanical actuators (right and left parking brake motors) into the rear disc brake callipers. The EPB system replaces the traditional handbrake system.

When the vehicle is stationary or when the EPB/Auto hold button is pressed the EPB control module activates the parking brake motors on the rear wheels holding the vehicle in place.

Pre-test conditions:

- The vehicle must be stationary
- The vehicle must be on level ground

- The brake fluid level is correct
- The Parking brake is OFF

NOTE: During the process of releasing and resetting the brake pistons the ECM may store DTCs in the EPB or ABS control modules. After completing the calibration procedure the EPB and ABS DTC memory must be cleared.

EPB for Audi A4/A5/A6 & VW Passat/Tiguan

Select the required option from the 'Maintenance' menu either 'Replace Pads' or 'Service Brakes' then follow described sequence.

Brake pad replacement/service sequence

The EPB system must be released and deactivated. Ensure the ignition is ON before following the sequence described below.

NOTE: If the sequence is not performed in the correct order the braking system may not operate correctly.

Release brakes

Select the 'Release Brakes' option from the menu. The brake pistons will now be moved to their released position. Wait until the service tool displays the release brakes now complete message before continuing.

Replace/service the brake pads

The brake pads can now be replaced or serviced following the manufacturer's instructions.

Close brakes

Select the 'Close Brakes' option from the menu. The brake pistons will now be moved to their reset position. Wait until the service tool displays the close brakes now complete message before continuing.

Calibrate brakes

Select the 'Calibrate Brakes' option from the menu. The brake pistons will now be moved in and out to calibrate their position. Wait until the service tool displays the 'Calibrate Brakes Now Complete' message before continuing.

EPB for Audi A8

Select the required option from the 'Maintenance' menu either 'Replace Pads' or 'Service Brakes' then follow the required sequence.

Brake pad replacement sequence (only)

The EPB system must be released and deactivated. Ensure the ignition is ON before following the sequence described below.

FastCheck

NOTE: If the sequence is not performed in the correct order the braking system may not operate correctly.

Replace pads

Select the 'Replace Pads' option from the 'Replace Pads' menu. The brake pistons will now be moved to their released position. Wait until the service tool displays the 'Release Brakes Now Open for Pad Change' message before continuing.

Replace the brake pads

Make a note of the new pad thickness as it is required for the next stage. The brake pads can now be replaced following the manufacturer's instructions.

Pad thickness

The brake pad thickness must now be entered by selecting 'Pad Thickness' from the 'Replace Pads' menu. The current value is displayed on screen. Press the ✓ key until the value you wish to change is highlighted. Use the ▲ and ▼ keys to enter the new value. Values must be between 3-14mm. Repeat this sequence if necessary. When each digit is correct press the ✓ key to move to the 'Store New Value' screen. Pressing the ✓ key again will store the new value to the control module.

Close brakes

Select the 'Close Brakes' option from the 'Replace Pads' menu. The brake pistons will now be moved to their reset position. Wait until the service tool displays the 'Close Brakes Now Complete' message before continuing.

Calibrate brakes

Select the 'Calibrate Brakes' option from the 'Replace Pads' menu. The brake pistons will now be moved in and out to calibrate their position. Wait until the service tool displays the 'Calibrate Brakes Now Complete' message before continuing.

Brakes service sequence (only)

The EPB system must be released and deactivated. Ensure the ignition is ON before following the sequence described below.

NOTE: If the sequence is not performed in the correct order the braking system may not operate correctly.

Release brakes

Select the 'Release Brakes' option from the 'Service Brakes' menu. The brake pistons will now be moved to their released position. Wait until the service tool displays the 'Release Brakes Now Complete' message before continuing.

Service the brakes

The brakes can now be serviced following the manufacturer's instructions.

Close brakes

Select the 'Close Brakes' option from the 'Service Brakes' menu. The brake pistons will now be moved to their reset position. Wait until the service tool displays the 'Close Brakes Now Complete' message before continuing.

Calibrate brakes

Select the 'Calibrate Brakes' option from the 'Service Brakes' menu. The brake pistons will now be moved in and out to calibrate their position. Wait until the service tool displays the 'Calibrate Brakes Now Complete' message before continuing.

FastCheck SAS

Connection

Using the Vehicle Application List on the CD-ROM, identify the required interface cable for the vehicle system to be tested. Connect the cable to the service tool and secure the fixing screws.

NOTE: If the vehicle being tested is a BMW with a 20 pin connector and an EOBD (J1962) connector, you must only use the 20 pin connector.

NOTE: The CAN converter (YTD960) harness must be used for any diagnostics on the following vehicles:

BMW 1 series (E81/E87)

BMW 3 series (E90/E91/E92/E93)

BMW 5 series (E60/E61)

BMW 6 series (E63/E64)

BMW 7 series (E65)

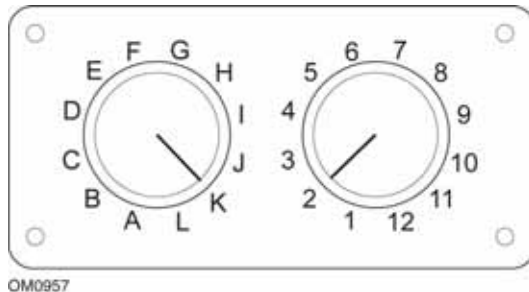

If using the EOBD (J1962) pin-switchable cable (YTD951), ensure the settings on the switch box correspond to the settings listed for the vehicle and system being tested.

WARNING: Incorrect settings on the switch box may cause irreparable damage to the vehicle's electrical system.

Ensure the vehicle's ignition is OFF.

Connect the service tool to the required vehicle connector, refer to '*Diagnostic connector locations*', page 56, for further information.

Power for the service tool is provided by the vehicle connector. Once connected, the service tool will perform an internal self test and then the screen will display the version of the current software before displaying the main menu.

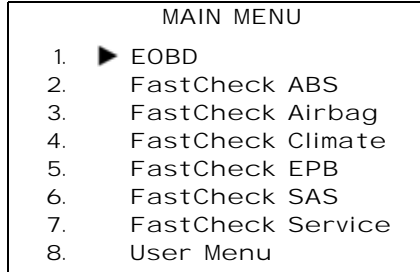

Use the ▲ and ▼ keys to select the 'FastCheck SAS' function and press ✓ to confirm the selection. To return to the previous menu, press the ✕ key.

Turn the vehicle's ignition ON.

Use the ▲ and ▼ keys to select the vehicle manufacturer and press ✓ to confirm the selection.

Dependant upon the vehicle and function being run, you may be asked to choose the particular system fitted to the vehicle. Select the correct system using the ▲ and ▼ keys and press ✓ to confirm.

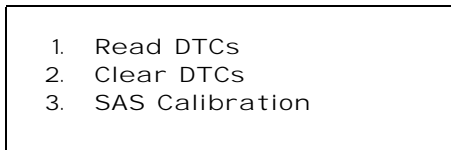

Select the required menu option using the ▲ and ▼ keys and press ✓ to confirm.

The service tool will attempt to establish communication with the vehicle system. If communication is unsuccessful, refer to '*Communication problems*'; page 6.

Read DTCs

If any DTC codes are present in the system, a screen will be displayed informing you how many codes were found. This will then be replaced by the first DTC code. DTC codes are generated according to the vehicle and system manufacturer.



A typical DTC code

FastCheck

The fault number is displayed first, followed by the DTC code. In this example the fault displayed is DTC number 38 - Right Low Pressure Sensor Circuit Signal High or Open Circuit. If the description text is too long to fit on the display, '(...)' appears in the bottom right corner of the screen. This indicates that the text can be scrolled using the ▲ and ▼ keys to view the rest of the description.

To view the next DTC (if more than 1 was found), scroll to the end of the text and press the ✓ key.

To return to the menu, scroll to the end of the text and press the ✕ key.

Clear DTCs

Diagnostic trouble codes can be cleared using the 'Clear DTCs' option. When using the option you will be prompted to turn the ignition off. Wait until prompted before switching the ignition back on.

Start the engine to force the control module to run a system check. Verify that the code(s) have been cleared by selecting 'Read DTCs'.

NOTE: Reading DTC(s) without first starting the engine will only confirm that the stored DTC(s) have been cleared. Faults may still be present in the system causing a DTC to be stored next time the engine is started.

SAS (Steering Angle Sensor) Calibration

The steering angle sensor can be calibrated using the 'SAS Calibration' option. The on screen instructions must be performed to ensure the calibration process is correctly completed.

NOTE: The steering angle sensor should be calibrated after performing the wheel alignment or suspension adjustments.

BMW vehicles

NOTE: To switch the ignition ON for vehicles fitted with a start/stop button, insert the remote key-fob fully into the ignition slot then press the start/stop button once (without any foot pedals depressed).

FastCheck service

Connection

Using the Vehicle Application List on the CD-ROM, identify the required interface cable for the vehicle system to be tested. Connect the cable to the service tool and secure the fixing screws.

NOTE: If the vehicle being tested is a BMW fitted with both a 20 pin connector and an EOBD (J1962) connector, you must only use the 20 pin connector.

NOTE: If the vehicle being tested is a Mercedes fitted with both a 38 pin connector and an EOBD (J1962) connector, you must only use the 38 pin connector.

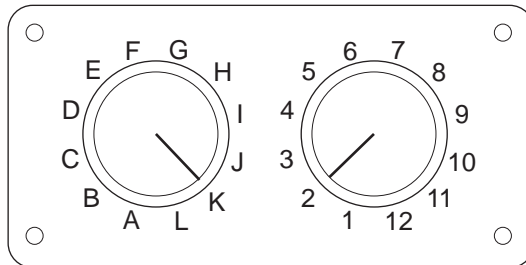

OM0957

If using the EOBD (J1962) pin-switchable cable (YTD951), ensure the settings on the switch box correspond to the settings listed for the vehicle and system being tested.

WARNING: Incorrect settings on the switch box may cause irreparable damage to the vehicle's electrical system.

Ensure the vehicle's ignition is OFF.

Connect the service tool to the required vehicle connector, refer to '*Diagnostic connector locations*', page 56, for further information.

Power for the service tool is provided by the vehicle connector. Once connected, the service tool will perform an internal self test and then the screen will display the version of the current software before displaying the main menu.

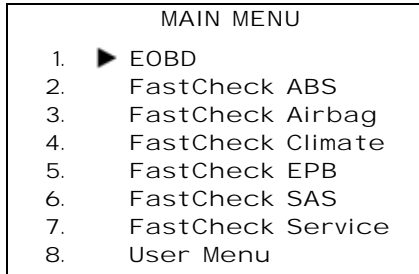

Use the ▲ and ▼ keys to select the 'FastCheck Service' function and press ✓ to confirm the selection. To return to the previous menu, press the ✕ key.

Turn the vehicle's ignition ON.

Use the ▲ and ▼ keys to select the vehicle manufacturer and press ✓ to confirm the selection.

Dependant upon the vehicle manufacturer and model different menu options will then be available.

Alfa Romeo vehicles (UK only)

For Alfa Romeo vehicles with the Mannesman Dashboard (147 and GT) there is a problem with the Dashboard which causes the 'Number of miles to Service' value to be set to zero when a Service Reset is performed using the service tool.

When the Service Reset is performed the Dashboard stores the current mileage (or kilometre) value, read from the Odometer, in order to calculate when the next service is required.

However, when the Odometer is shown in miles the calculation for the distance to the next service fails. This results in distance to the next service being displayed as zero and the Service Reset fails to be completed.

To reset the Service Interval the following procedure must be performed:

1. Switch the Ignition ON.
2. Press the [MODE] button on the dashboard to enter the dashboard functions menu.
3. Use the [+] and [-] buttons on the dashboard to navigate to the UNITS option and press [MODE] to select.
4. Use the [MODE], [+] and [-] buttons to set the units to Kilometres. All other settings should be left unchanged.
5. Use the [+] and [-] buttons on the dashboard to navigate to the END MENU option and press [MODE] to exit the functions menu.

6. Plug the service tool into the Diagnostic Socket (using the 16-pin FAL LS CAN harness) and perform a Service Reset by selecting FastCheck Service, Alfa Romeo, Mannesman then Service Reset.
7. Disconnect the service tool, leaving the ignition ON.
8. Press the [MODE] button on the dashboard to enter the dashboard functions menu.
9. Use the [+] and [-] buttons on the dashboard to navigate to the UNITS option and press [MODE] to select.
10. Use the [MODE], [+] and [-] buttons to set the units back to Miles. All other settings should be left unchanged.
11. Use the [+] and [-] buttons on the dashboard to navigate to the SERVICE option and press [MODE] to select.
12. 'Number of Miles to Service' should now read approximately 12500 miles.
13. Use the [+] and [-] buttons on the dashboard to navigate to the END MENU option and press [MODE] to exit the functions menu.
14. Switch Ignition OFF.

This procedure is necessary to ensure that the value read from the Odometer by the dashboard, when a Service Reset is performed by the service tool, is in Kilometres. The Dashboard can then calculate the 'Number of Miles to Service' correctly.

On the European Continent this procedure is not necessary as all dashboards are in Kilometres.

BMW vehicles

NOTE: To switch the ignition ON for vehicles fitted with a start/stop button, insert the remote key-fob fully into the ignition slot then press the start/stop button once (without any foot pedals depressed).

Manufacturer	Option 1	Option 2
BMW	CBS	Service options
	Digital reset	Oil reset
		Distance reset
		Time reset
	Analogue reset	Oil
		Inspection service

Use the ▲ and ▼ keys to select the required menu option and press ✓ to confirm the selection. To return to a previous menu, press the ✕ key.

The screen will display the message "BMW Reset" to confirm the reset process was completed successfully.

FastCheck

Select 'Condition Based Service' (CBS):

NOTE: All required work must be carried out before service indicators are reset. Failure to do so may result in incorrect service values and cause DTCs to be stored by the relevant control module.

NOTE: The DSC module will not recognise the replacement of the brake pad wear sensor before a terminal change has taken place. As such the DSC module will not allow reset of the brake pad service items.

It is recommended that the brake pads are replaced with OE equivalent parts. The DSC module may not recognise a terminal change if using non-genuine brake pads.

Select CBS for vehicles only fitted with a J1962 16 pin connector and support CBS.

Applicable vehicles:

BMW 1 series (E81/E87)

BMW 3 series (E90/E91/E92/E93)

BMW 5 series (E60/E61)

BMW 6 series (E63/E64)

BMW 7 series (E65)

NOTE: The CAN converter (YTD960) harness must be used for CBS.

CBS is a system in which the vehicle calculates and monitors the status of serviced components and fluid levels as well as time and mileage based services.

The following table displays possible service options together with the control module used to reset each option.

Service option	Control module
Engine oil	Engine (DME/DDE)
Particulate filter	Engine (DDE)
Front brake pads	Dynamic stability control (DSC)
Rear brake pads	Dynamic stability control (DSC)
Micro filter	Climate control (IHKA)
Brake fluid	Instrument cluster (INSTR)
Coolant	Instrument cluster (INSTR)
Spark plugs	Instrument cluster (INSTR)
Vehicle check	Instrument cluster (INSTR)
Statutory vehicle inspection	Instrument cluster (INSTR)
Statutory exhaust emission inspection	Instrument cluster (INSTR)

The service tool will automatically identify all control modules required during the reset process. If an unknown control module is found or communications cannot be established, the operator is prompted to either continue or abort.

NOTE: If the process is continued service options applicable to the unknown control module will not be available (see service option table).

The current date and time information will be displayed by the service tool. Press the ✓ key if the information is correct and continue or press ✕ key to correct the information.

NOTE: If date and time used during the reset process is incorrect, this will result in incorrect service intervals.

To change the date and time:

Use the ▲ and ▼ keys to change the value of the selected information indicated by '/'\.

Use the ◀▶ key to change the selected date/time field.

Use the ✓ key to complete the information entry.

The screen will display a final confirmation of the new data entered. Press the ✓ key to program the new information to the vehicle.

Pressing the ✕ key at any point during the date and time change to will return to the initial date and time confirmation screen. No information will have been changed.

The service options available on the vehicle are displayed as a list. Each option is displayed with the service data:

The percentage reset value.

The estimated distance to, or the next service date.

The service counter.

NOTE: The vehicle inspection and exhaust emission inspection only display the date of the next service.

The service option list is displayed in priority order, with the most urgent first.

To reset an option scroll to the required option using the ▲ and ▼ keys. The current option will be indicated by the ▶. Press the ✓ key to confirm the selection.

Two possible options may be displayed on the lower half of the display:-

Reset option

FastCheck

Correct option

Use the ▲ and ▼ keys to select the required menu option

Use the ✓ key to confirm the selection.

Use the ✕ key to cancel the selection and return to the service option list.

Reset option:

The 'Reset' option is used to set the selected service option's reset value to 100%. The estimated distance or date of next service and the service counter are updated.

The vehicle inspection and exhaust emission inspection service options are statutory inspections that store the date of the next inspection.

Upon selecting either of these options the service tool will display the screen to change the next service date.

Use the ▲ and ▼ keys to change the value of the selected information indicated by '>' or '<'.

Use the ◀▶ key to change the selected field.

Use the ✓ key to complete and store the information.

Use the ✕ key to cancel the reset and return to the service option list.

Correct Option:

The 'Correct' option is used to correct a service option which has been reset in error.

NOTE: Reset correction is only available for service options with service counter not zero, and is not available for vehicle and exhaust emission inspections. The original service option values are lost during reset.

Use the ▲ and ▼ keys to change the reset value.

Use the ✓ key to complete the information entry.

A final confirmation of the new data entered is displayed. Press the ✓ key to store the new information. To cancel the correction and return to the service option list press the ✕ key.

NOTE: The maximum reset value will be the current value of the selected service option. The service counter will be decremented by 1.

Digital Reset:

Select 'Digital Reset' for vehicles only fitted with a J1962 16 pin connector that do not support Condition Based Service (CBS).

The service tool will display a message to confirm the reset process was successful.

Applicable vehicles:

BMW 3 Series (E46)

BMW 5 Series (E39)

BMW 7 Series (E38)

BMW X3 (E83)

BMW X5 (E53)

BMW Z4 (E85)

NOTE: A manual procedure for service reset is possible for some Digital Reset applicable vehicles. Refer to Manual Service Reset section for instructions.

Analogue reset:

Select 'Analogue Reset' for vehicles fitted with a 20 pin round diagnostic connector within the engine bay.

The service tool will display the message 'Reset Complete' to confirm the reset process was completed.

NOTE: The service tool indicates the completion of the process only. Visual confirmation via the Service Interval Indicator (SIA) located on the vehicle's dash panel is required.

Annual distance:

The average annual distance travelled is required for the calculation of various Condition Based Service (CBS) functions.

The annual distance is based on the distance travelled after approximately six to eight weeks from being reset. It is advised to reset the annual distance after any changes in the driving pattern of the vehicle.

NOTE: Incorrect annual distance will affect the CBS intervals.

The value will be set to a default (approximately 30,000 km / 18,640 miles) until the new value has been calculated.

Applicable vehicles:

BMW 1 series (E81/E87)

BMW 3 series (E90/E91/E92/E93)

BMW 5 series (E60/E61)

BMW 6 series (E63/E64)

BMW 7 series (E65)

FastCheck

NOTE: The CAN converter (YTD960) harness must be used.

Battery change:

After fitting a new battery, the battery change function should be run. The battery change function registers the replacement of a battery with the power management system. Failure to do so may cause the power management system to operate incorrectly.

The battery change function determines the required battery capacity and type from the Car Access System (CAS) module. The replacement battery must be same capacity and type as displayed.

NOTE: Certain vehicles require the use of an Absorbent Glass Mat (AGM) battery.

Applicable vehicles:

BMW 1 series (E81/E87)

BMW 3 series (E90/E91/E92/E93)

BMW 5 series (E60/E61)

BMW 6 series (E63/E64)

BMW 7 series (E65)

NOTE: The CAN converter (YTD960) harness must be used.

GM vehicles

Service interval reset

CAN vehicles - (Astra-H, Corsa-D, Signum, Vectra-C and Zafira-B)

For these vehicles the CAN converter cable (YTD960) must be used for Service Interval reset.

This function should be used after a vehicle has been serviced.

The vehicle is programmed with the number of miles and days until the next service and the Service indicator light is turned off.

The Service indicator will come on again when either the number of programmed miles is reached or the number of programmed days is reached, whichever occurs first.

The reset is started by selecting the 'Service' option.

To return to a previous menu, press the **X** key.

The operator must then select the 'CAN Converter cable'.

The service tool will communicate with the Instrument pack to determine the vehicle model. If the vehicle model is unknown the operator must manually select the vehicle.

NOTE: Vehicle must NOT be moving during this procedure and all doors must be closed. The service tool will check the vehicle speed to ensure that the vehicle is not moving before starting the procedure.

Security key

To perform the reset the operator must enter a 4-digit security key into the service tool. This code will be programmed into the vehicle to allow a Reset to be performed.

The 4-digit security key is found in the owner's handbook on a card with the other important codes and numbers for the vehicle (such as the VIN number and Radio code etc.).

Corsa D

The number of miles until the next service can be selected by the user, 9000 miles or 18000 miles can be selected. The number of days until the next service is always set at 364 days (1 year).

Astra-H / Zafira-B

The number of miles until the next service and number of days until the next service are calculated by the service tool depending on the operators selections of the following:

1. **Country** - The miles and days until next service are set to values pre-determined by GM, depending on the Country the vehicle is being used in.

The operator must first select the Continent and then the Country.

For core European Countries (UK, Ireland, France, Belgium, Germany, Spain, Italy, Portugal, Holland, Austria etc.) select 'Other European Countries'.

2. **ECO service, ECO service flex** - For most core European countries the Operator can set the vehicle to either 'ECO Service' (the standard GM service plan which used standard GM values for miles and days until next service) or 'ECO Service Flex' (the values for miles and days until next service are dynamically set by the vehicle's onboard computers, which monitor how the vehicle is being driven and set the Service Intervals accordingly).

For ECO Service Flex Petrol vehicles the service tool will program the vehicle with the maximum number of miles allowed by the Flex system (22000 miles) and the maximum number of days allowed (728, or 2 years).

For ECO Service Flex Diesel vehicles the service tool will program the vehicle with the maximum number of miles allowed by the Flex system (31000 miles) and the maximum number of days allowed (728, or 2 years).

These are default values which ensure that the Service Indicator will come on in either 22000 or 31000 miles or 2 years, whichever occurs first, if the ECO Service Flex system fails for any reason.

FastCheck

Vectra-C / Signum

Only a straight reset is available on these vehicles. The programmed Service Interval values of miles and days until the next service cannot be altered.

NOTE: The engine oil used on these vehicles is 'Long-life Oil'. When the engine oil is changed the technician must use the 'Long-life Oil' reset option on the service tool (see below) to reset the Engine Control Module. The technician must then select 'Service' again to restart the Service Interval Reset.

CAUTION: It is important to depress, and release, the brake pedal when prompted by the service tool during the Reset procedure. If this is not done correctly the Reset will not be successful.

Pre-CAN vehicles

The EOBD (J1962) pin-switchable cable (YTD951) must be used for pre-CAN vehicles, with switch position J2.

This function should be used after a vehicle has been serviced.

The vehicle is programmed with the number of miles and days (whichever one occurs first) until the next service. Completing this step turns the Service Indicator light OFF.

The reset is started by selecting the 'Service' option.

To return to a previous menu, press the **X** key.

The operator must then select the 'Switchable' cable.

Please ensure that the vehicle is stationary and check that all the vehicle's doors are closed.

Press **✓** on the service tool to reset the Service Interval.

If successful the service tool will display 'Service Reset Passed'.

Long-Life oil reset

CAN Vehicles - (Vectra-C and Signum)

For these vehicles the EOBD (J1962) cable (YTD950) or the CAN converter cable (YTD960) can be used for Long-Life Oil Reset.

NOTE: The engine must NOT be running when performing this procedure.

This function must be used when an engine oil change has been performed on the vehicle.

The Long-Life Oil Reset is started by selecting the 'Long-Life Oil' option.

The Technician must then select the cable to be used.

The service tool will check the Engine Control Module to ensure that the function is supported for the current engine. This function is not supported and not necessary on Astra-H, Corsa-D or Zafira-B.

The service tool will check the engine speed to ensure that the engine is not running then read the current value of 'Remaining Oil Life' from the Engine Control Module and display. If the value is less than 15% the Oil must be changed and a reset performed.

The service tool will then perform the Reset. The 'Remaining Oil Life' parameter will be read from the Engine Control Module and displayed again. It will read 100% if the reset has been successful.

Mercedes vehicles

There are two different types of servicing for Mercedes: Assyst Plus and Flexible Service System. The service type will automatically be determined from the vehicle.

Assyst Plus:

NOTE: Any DTCs (Diagnostic trouble codes) present on the Assyst Plus control module may lead to incorrect servicing information and services to be performed incorrectly. Different variants of Assyst Plus have different service functions available.

Assyst Plus service functions

- *Reset indicator*
- *Additional work*
- *Service status*
- *Service history*
- *Undo reset*
- *Undo additional*
- *Read DTCs*
- *Clear DTCs*

Reset Indicator

This function is used to reset the overall maintenance of the vehicle. The current service status information will be displayed.

To abort the reset, press the **X** key. Confirmation of the service being aborted will be displayed, press any key at this point to return to the 'Assyst Plus' menu. To proceed with the reset press **✓**.

The oil quality must be selected before the reset can be completed. To abort the reset, press the **X** key. Confirmation the reset has aborted will be displayed, press any key to return to the 'Assyst Plus' menu. To select the oil quality used for the service from the menu use the **▲** and **▼** keys and press to confirm the selection.

FastCheck

The result of the reset will be displayed, press any key to return to the 'Assyst Plus' menu.

Additional Work

This function is used to record additional work carried out during the latest service in the vehicle's service memory.

The function will display a menu of all available additional work options applicable for the vehicle.

Press the ▲ and ▼ keys to scroll through the available list.

Press the ◀▶ key to select/deselect an item. Multiple items can be selected and any items selected are highlighted by > .

Press the ✕ key to abort and return to the 'Assyst Plus' menu. Press ✓ to add these selected options to the last service memory. The result of the reset will be displayed, press any key to return to the 'Assyst Plus' menu.

Service Status

This function displays the current service status information.

Use the ▲ and ▼ keys to scroll through the status information. Press the ✕ key to exit and return to the 'Assyst Plus' menu.

NOTE: It can take some time for the control unit to update the service status information after a change in state (e.g. Resetting the service indicator).

Service History

This function allows the operator to review the entries held within the service memory. The function will display the number of service entries currently stored within the service memory.

Press the ✕ key to return to the 'Assyst Plus' menu. Select the desired entry using the ▲ and ▼ keys and press ✓ to confirm the selection.

Press the ✕ key to return to the 'Assyst Plus' menu. Press ▲ and ▼ keys to scroll through the service information stored in memory.

Undo Reset

This function cancels the latest service stored in the service history (i.e. the last performed service).

NOTE: A warning will be displayed before the cancel process is performed. This option is only intended for resetting a service that has accidentally been reset.

Press ✕ to return to the 'Assyst Plus' menu. Press ✓ to cancel the last service. Confirmation of the cancellation will be displayed. Press any key at this point to return to the 'Assyst Plus' menu.

NOTE: Services which have been cancelled remain in the service history. The entry will be marked as irrelevant and the data held within will be reset. The Undo Reset is only possible if there is an existing service held within the service memory.

Undo Additional

This function cancels any additional work records stored in the latest service history.

NOTE: A warning will be displayed before the undo process is performed. This option is only intended for resetting an additional service option that has accidentally been reset.

A menu of all the additional work available from the vehicle's latest service is displayed.

Press ▲ and ▼ keys to scroll through the available list.

Press the ◀▶ key to select/deselect an item. Multiple items can be selected and any items selected are highlighted by > .

Press ✕ to return to the 'Assyst Plus' menu. Press ✓ to remove the selected options from the service memory. The result of the undo will be displayed, press any key to return to the 'Assyst Plus' menu.

NOTE: Undo is only possible if there is an existing service held within the service memory and the selected service options are applicable to the latest service.

Flexible Service System:

Select 'Service Reset' and press ✓ to confirm the selection. To return to a previous menu, press the ✕ key.

When prompted to, check that all the vehicle's doors are closed, then press any button on the service tool to have the oil or service light reset.

Warning: Be sure to close all the vehicle's doors before sending the reset command. Not doing so can result in permanent damage to the vehicle's instrument panel.

You will receive the message "Mercedes Reset" to confirm the reset process was completed successfully.

MG Rover vehicles

Scroll through the list of available vehicle models and press ✓ to confirm the selection. To return to a previous menu, press the ✕ key.

When prompted to, check that all the vehicle's doors are closed, then press any button on the service tool to have the oil or service light reset.

You will receive the message "MG Rover Reset" to confirm the reset process was completed successfully.

FastCheck

Saab vehicles

Select 'Interval and Oil' and press ✓ to confirm the selection. To return to a previous menu, press the ✕ key.

You will receive the message "Saab Reset" to confirm the reset process was completed successfully.

Volvo vehicles

Select 'Service' and press ✓ to confirm the selection. To return to a previous menu, press the ✕ key.

You will receive the message "Volvo Reset" to confirm the reset process was completed successfully.

VAG (Volkswagen and Audi) vehicles

Manufacturer	Option 1	Option 2	Option 3	Option 4	Option 5
		Adaptation - Refer to Variable Service Reset section			
VAG	Service Reset	Service Reset	Long Life Oil	Service Reset	N/A
				Set Oil Type	Diesel
					V6 TDI
					Petrol
				Non Long Life Oil	
			View Oil Type	N/A	
			Non Long Life Oil	Service Reset	N/A
Service	Inspection 1	N/A			
	Inspection 2	N/A			

Use the ▲ and ▼ keys to select the required menu option and press ✓ to confirm the selection. To return to a previous menu, press the ✕ key.

You will receive the message 'VAG Reset' to confirm the reset process was completed successfully.

Variable Service Reset (VAG)

For some VAG (Audi and VW) vehicles manufactured since 2000, the 'Variable Service Reset' option must be used. Refer to the Vehicle Application List.

WARNING: Changing the baseline / learn values of any channel could have adverse effects on engine performance and running. If you have any doubt please consult somebody familiar with the system.

Service Type	Adaptation	Channel	Counter Contents	Value to Reset
Service	Service Reset	2	Reset service counters (distance and time)	00000
		40	Distance travelled since last service ÷ 100.	00000
		41	Time elapsed (in days) since last service	00000
		42	Lower limit for distance to next inspection	-----
		43	Upper limit for distance to next inspection	-----
		44	Upper limit for time to next inspection	-----
		45	Quality of engine oil	-----

To reset the service interval, use the ▲ and ▼ keys to select channel 2 and press ✓ to confirm the selection.

Change the value of the channel to 00000 to reset both the time and distance service counters. Use the ▲ and ▼ keys to change each digit to 0 and press ✓ to confirm.

NOTE: Channels 40, 41, 42, 43, 44 and 45 are used when installing a new instrument pack. Values from the original instrument pack must be entered into the new instrument pack to ensure that vehicle servicing is carried out at the correct intervals.

Diagnostic connector locations

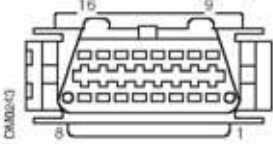
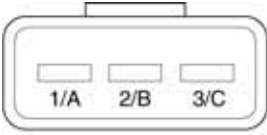
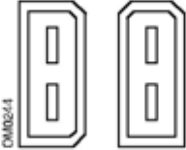
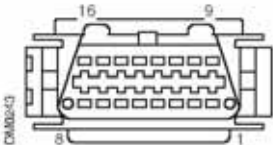
Alfa Romeo	J1962	Under the driver's side dashboard or in the fuse box.	
	3-pin	Airbag/ABS <ul style="list-style-type: none"> • Engine compartment – normally centre: 145, 146, 155, GTV/Spider • Engine compartment – normally right: 145, 146, 155, 164, GTV/Spider • Under dashboard – driver's side: 147,156,166,GTV/Spider • Passenger glove box: 145, 146, GTV/Spider 	
Audi	2-pin ISO 9141	Engine compartment relay box.	
	J1962	Driver's footwell under the steering column or the centre console beneath a removable panel.	

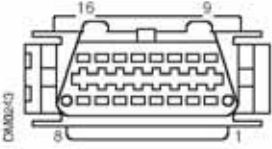
<p>BMW</p>	<p>20-pin round connector</p>	<p>Engine compartment.</p>	
	<p>J1962</p>	<p>If the vehicle is fitted with a J1962 diagnostic connector, this can usually be located in the driver's footwell behind a cover. <i>NOTE: If the BMW vehicle under test has both the round (20 pin) diagnostic connector and the J1962 (16 pin) connector, the round connector should always be used to access information via the BMW application and the J1962 connector should be used to access data via the EOBD application (ensure the cap is fitted to the 20-pin connector). If the cap is not fitted, the J1962 connector will not function correctly.</i></p>	

FastCheck

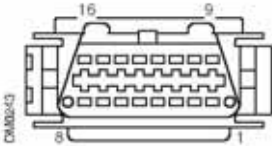
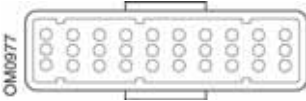
Citroen	J1962	<p>Saxo: - Under dashboard - passenger side.</p> <p>AX (1997), Berlingo: - Under dashboard - driver's side</p> <p>C3, C6, C8, Xsara, Picasso, Xantia,</p> <p>Evasion: - Fascia fuse box.</p> <p>C5: - Glove box.</p> <p>C1: - To left of steering column.</p> <p>C6: - Centre console compartment.</p>	
	30-pin connector	<p>Saxo: - Passenger side - below dash.</p> <p>Berlingo, Synergie,</p> <p>Evasion: - Driver's side - below dashboard.</p> <p>XM, Xantia: - Fascia fuse box.</p>	

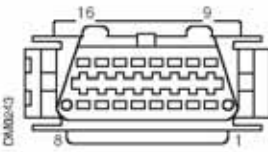
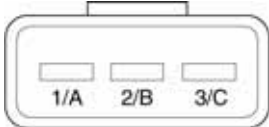
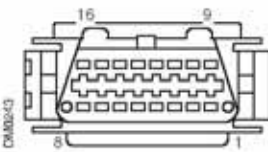
Fiat	J1962	Driver's side dashboard or in the fuse box with the exception of the Palio/RST where it is in the centre console, under the handbrake.	
	3-pin	Airbag/ABS <ul style="list-style-type: none"> • Under dashboard – driver's side/ passenger glove box: Barchetta, Bravo-Brava, Coupe, Doblo, Ducato, Idea, Marea, Multipla, Palio, Panda, Punto, Seicento, Stilo • Engine compartment – normally right: Bravo-Brava, Croma, Ducato, Marea, Palio, Punto, Seicento • Engine compartment – normally centre: Bravo-Brava, Croma 	 <p>OM1076</p>
Ford	J1962	Courier, Fiesta, Ka: - Passenger compartment - bottom of 'A' pillar. Focus, Mondeo, Scorpio: - Central junction box - below steering column. Galaxy: - Behind ashtray- centre console. Transit: - Passenger compartment fuse box - behind spare fuse tray. Puma: - Passenger side- bottom of 'A' pillar. Cougar: - Under dash panel - centre.	

FastCheck

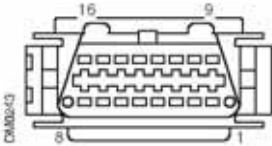
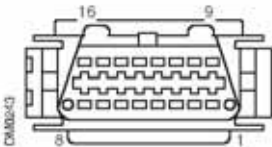
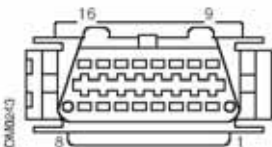
<p>GM Vauxhall/ Opel</p>	<p>J1962</p>	<p>Corsa C, Astra G, Astra H, Meriva, Vectra B, Zafira A, Zafira B: - Below cover - front of handbrake. Agila, Tigra, Speedster/VX220, Sintra, Vivaro: - Below dashboard - driver's side. Astra F, Corsa B, Omega B: - Fuse box - passenger compartment. Corsa C, Corsa D: - Centre console - below heater controls. Frontera, Vectra C, Signum: - Centre console - under ashtray.</p>	 <p>A technical diagram of a fuse block. It shows a top-down view of a rectangular component with two rows of fuse slots. The top row has 16 slots, and the bottom row has 8 slots. Terminals are labeled: '16' at the top left, '9' at the top right, '8' at the bottom left, and '1' at the bottom right. A vertical label 'DM02-43' is on the left side.</p>
<p>Lancia</p>	<p>J1962</p>	<p>Under the driver's side dashboard or in the fuse box with the exception of the Phedra where it is in the driver's side footwell.</p>	 <p>A technical diagram of a fuse block, identical to the one in the first row. It shows a top-down view of a rectangular component with two rows of fuse slots. The top row has 16 slots, and the bottom row has 8 slots. Terminals are labeled: '16' at the top left, '9' at the top right, '8' at the bottom left, and '1' at the bottom right. A vertical label 'DM02-43' is on the left side.</p>
<p>Land Rover</p>	<p>J1962</p>	<p>Driver or passenger's footwell. Defender - centre console behind removable panel.</p>	 <p>A technical diagram of a fuse block, identical to the ones in the previous rows. It shows a top-down view of a rectangular component with two rows of fuse slots. The top row has 16 slots, and the bottom row has 8 slots. Terminals are labeled: '16' at the top left, '9' at the top right, '8' at the bottom left, and '1' at the bottom right. A vertical label 'DM02-43' is on the left side.</p>

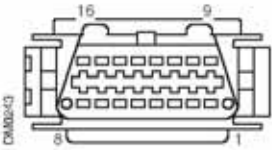
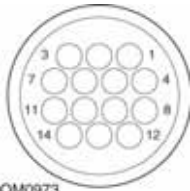
<p>Mercedes Benz</p>	<p>38-pin round connector</p>	<p>Engine compartment - usually along bulkhead, but the precise location may vary. <i>NOTE: For those vehicles which have both the round 38-pin connector and the OBD II connector:</i></p> <ul style="list-style-type: none"> • The round 38-pin connector should always be used to retrieve data via the Mercedes application. • The OBD II connector should always be used only to retrieve data via the OBD II application. 	
	<p>J1962</p>	<p>Driver's footwell under the steering column or the centre console beneath a removable panel.</p>	
	<p>14-pin round connector (Sprinter)</p>	<p>Passenger's footwell under fascia behind removable cover. <i>Some Mercedes vans have a 14-pin round connector which is located under the passenger side dashboard, other vehicles may have the 16-pin OBD II connector.</i> <i>The 14 pin round connector should always be used to retrieve data via the Mercedes application. It does not support OBD II.</i></p>	

FastCheck

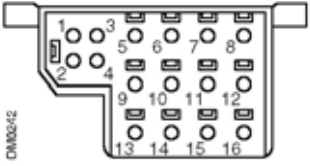
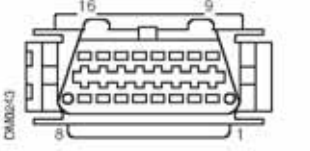
<p>Mercedes OBD-1</p>	<p>16-pin connector block</p>	<p>Engine compartment - usually on the bulkhead adjacent to the fusebox.</p>	
<p>MG Rover</p>	<p>J1962</p>	<p>The diagnostic connector is located in one of three positions:</p> <ul style="list-style-type: none"> • Behind the 'A' post lower trim panel in the driver's footwell. • On a bracket inside the centre console. <p><i>The connector is often mounted on a bracket so that it faces into the console. If this is the case, the J1962 socket needs to be removed from the bracket before connection can be made. To remove the diagnostic socket, squeeze together the two wings on the back of the socket and carefully pull the connector free from the bracket.</i></p> <ul style="list-style-type: none"> • Early MGF: - The J1962 connector is located inside a trim panel by the steering wheel just above the internal fuse box. 	

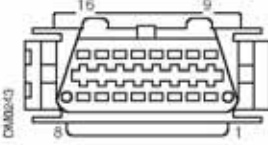
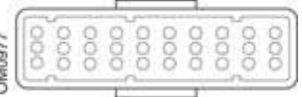
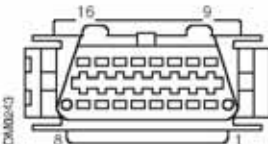
<p>Peugeot</p>	<p>J1962</p>	<p>106 (1997 on): - Under dashboard - passenger side. 206, 306, 806, Partner (1997 on): - Under dashboard - driver's side. 307 (to 2004), 406 (1997 to 2000), 807: - Fascia fuse box. 107: - To left of steering column. 307 (2004 on): - Behind ashtray in centre console. 406 (2000 on): - Driver's side dashboard (remove small plastic cover). 407, 607: - Centre console compartment.</p>	
	<p>30-pin connector</p>	<p>106 (to 1997): - Passenger side - below dash. 806, Partner (to 1997): - Driver's side - below dashboard. 406 (to 1997), 605: - Fascia fuse box.</p>	
<p>Renault</p>	<p>J1962</p>	<p>Clio: - Under ashtray - centre console. Espace: - Passenger footwell. Kangoo: - Driver footwell. Laguna: - Centre console - in front of gear lever. Laguna 2: - Centre console - under ashtray. Megane: - Driver footwell. Safrane: - Engine compartment - Near side front wing. Scenic: - Driver footwell.</p>	

FastCheck

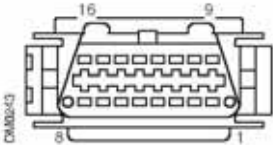
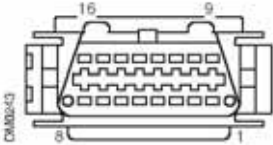
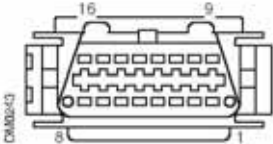
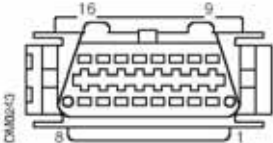
<p>Saab</p>	<p>J1962</p>	<p>Driver's footwell, under the steering column.</p>	
<p>Seat</p>	<p>J1962</p>	<p>Alhambra: - Centre console/ Footwell - Passenger. Arosa: - Fascia - Driver side. Ibiza, Cordoba: - Centre console - Driver side. Toledo: - Centre console.</p>	
<p>Skoda</p>	<p>J1962</p>	<p>Favourit, Felicia (1.3), Forman: - Under bonnet - Suspension turret - Near side. Felicia (1.6): - Footwell - Passenger side. Octavia: - Storage compartment - Driver's side.</p>	
<p>Volvo</p>	<p>J1962</p>	<p>S/V40: - Under dashboard - driver's side. S/V/C70: - Behind handbrake. 850: - In front of gear lever. 960: - Next to hand brake.</p>	

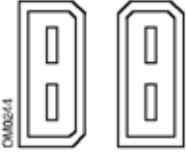
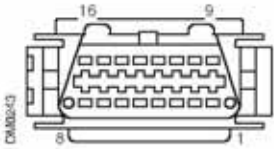
<p>VW</p>	<p>2-pin ISO 9141</p>	<p>Engine compartment relay box.</p>	
	<p>J1962</p>	<p>Bora: - Centre console. Corrado, Passat: - Dashboard - Centre. Golf, Vento: - Dashboard - Centre (remove ashtray). Lupo: - Centre console, Storage compartment or Front ashtray. Polo: - Dashboard - RH. Sharan: - Under gear lever cover. Transporter: - Adjacent to instrument panel or Fuse/relay box - Fascia. <i>NOTE: For more information, refer to the relevant technical manual.</i></p>	

Overview

USER MENU	
1.	OBD DTC Lookup
2.	Language Menu
3.	Tester Setup
4.	Self Test
5.	Software Version
6.	Security
7.	CAN Converter

Use the ▲ and ▼ keys to select the required function and press ✓ to confirm the selection.

NOTE: Press ✕ to return to the Main Menu.

OBD DTC Lookup

This option is used to look up a description of a known DTC.

1. Use the ◀▶ and ? keys to move the cursor under the required DTC character, then using the ▲ and ▼ keys, change the characters as required.
2. Press the ✓ key to confirm DTC.
3. Press ✕ to return to the User Menu.

If the unit recognises the DTC, the screen will display the full description. i.e. P0100 - Mass or Volume Air Flow 'A' Circuit.

Where more than one description is available, a separate menu will appear for you to select the appropriate option.

If a code is not recognised the message 'No Text Allocated for this Code' is displayed.

NOTE: Press ✕ to return to the User Menu.

Language Menu

The Language Menu allows you to change the software language if available.

1. Use the ▲ and ▼ keys to select the required language.
2. Press ✓ to confirm the selection.

NOTE: This menu is only enabled when more than one language is installed on the service tool. If only one language is installed, the message 'Not Enabled' will be displayed when the Language Menu option is selected and the display will return to the User Menu.

User menu

Tester Setup

The Tester Setup allows you to change the live data units, change the way live data is displayed and adjust the contrast of the screen.

1. Select 'Live Data Units' from the Tester Setup menu.

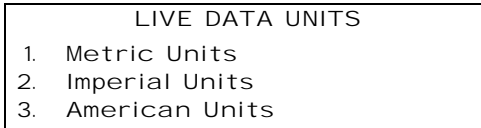

2. The currently selected live data units will be displayed on the screen. e.g. 'Metric Units set', before displaying the available options.
3. Use the ▲ and ▼ keys to select the preferred units of measurement and confirm by pressing the ✓ key. After updating, the unit returns to the Tester Setup menu.
4. Select 'Live Data Display' from the Tester Setup menu.

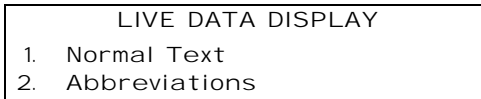

5. The currently selected live data display option will appear on the screen. e.g. 'Normal Text Set', before displaying the available options.
6. Use the ▲ and ▼ keys to select the preferred display option and confirm by pressing the ✓ key. After updating, the unit returns to the Tester Setup menu.
7. Select 'Contrast' from the Tester Setup menu.
8. Use the ▲ and ▼ keys to adjust the contrast of the screen and confirm by pressing the ✓ key. After updating, the unit returns to the Tester Setup menu.

NOTE: Press ✕ to return to the 'Tester Setup' menu.

Self test

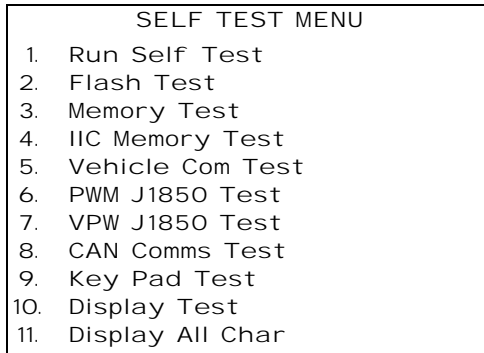

1. Use the ▲ and ▼ keys to select the required test.
2. Press ✓ to confirm selection.
3. Follow on-screen instructions to carry out specified test.
4. Press the ✓ or ✗ key as appropriate, to return to the Self Test Menu.

Software version

1. Once selected, the version number of the TRW easycheck software appears on the screen before displaying a list all software modules currently loaded onto the service tool.
2. Use the ▲ and ▼ keys to scroll through the software module list.
3. Press the ✓ or ✗ key to return to the Self Test Menu.

Security

All of the functions on the TRW easycheck are 'locked' by a security key. To unlock a particular function the appropriate security key must be obtained from the Product Support web site and entered into the TRW easycheck. If the expected functions are not displayed in the main menu it could be that the security key has not been entered, or is incorrect.

To examine or enter a security key, enter the 'Security' option. The following menu will be displayed:

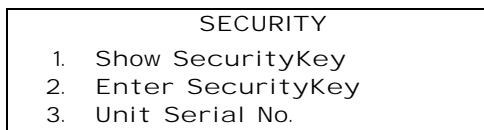

User menu

Show SecurityKey

1. Once selected, the security key is displayed on the screen as 20 characters. If it is incorrect the message 'Key is Invalid' will be displayed as well, and the **?** key may be pressed for further information which may be asked for by product support.
2. Press the **✓** or **✕** key to return to the User Menu.

Enter SecurityKey

This option is used to enter the security key to unlock the functions on the TRW easycheck.

1. Select 'Enter SecurityKey' from the security menu.
2. Using the **▲** and **▼** keys, scroll through the alpha/numerical character list.
3. Confirm each character by pressing the **✓** key.
4. If you make a mistake use the **◀▶** key and enter the correct character. To re-enter the code from the beginning, press the **✕** key.
5. When prompted to verify the security key, press **✓** to confirm.
6. Restart the TRW easycheck either by disconnecting and reconnecting the power supply or by pressing the outer 4 buttons on the handset at the same time.

*Note: The **?** button displays on-screen instructions. The **✕** button may be used to cancel the operation and the original key will be retained.*

Unit Serial No.

1. Once selected, the serial number of the TRW easycheck is displayed on the screen. This should match the number on the back of the unit. The serial number may be requested by product support when issuing security numbers. The user cannot change this number.
2. Press the **✓** key to return to the User Menu.

CAN Converter (Firmware update)

The CAN Converter option allows you to check and update the CAN converter cable (YTD960) firmware.

CAN CONVERTER	
1.	Get FW Version
2.	Update FW Version

NOTE: The CAN converter cable (YTD960) must be connected to service tool before this user menu option can be used.

Get FW Version

1. Select the 'Get FW Version' item to display the current version of the firmware within the CAN converter cable (YTD960).
2. Press **X** to return to the User Menu.

Update Firmware

1. Select the 'Update FW Version' item to check and update the version of the firmware within the CAN converter cable (YTD960).
2. A message will be displayed with the current version and whether a later version of the firmware is available. Press **X** to return to the User Menu. Press **✓** to continue the update process.

NOTE: The update process must be allowed to fully complete once started and the power must not be interrupted during the update process.

General information

Cleaning

To maintain the condition and serviceability of the service tool, it is advisable to follow the cleaning procedures below:

WARNING: Do not use solvents such as petroleum based cleaning agents, acetone, petrol, trichlorethylene etc. These types of harsh solvent may seriously damage the plastic casing. Do not even spray or pour this type of cleaner onto a cleaning cloth.

WARNING: The service tool is not waterproof. Always dry the unit thoroughly after cleaning or if it has been subject to accidental spillage.

The manufacturer recommends that you periodically inspect and clean the following parts of the service tool:

- The case
- The display screen
- The keypad
- Adaptor cables and connectors

To clean the service tool, or any of its cables or connectors, apply a mild detergent solution to a soft clean cloth that has been suitably dampened.

WARNING: Before cleaning, disconnect the service tool from the vehicle.

Display screen

During normal everyday use, the screen may become dusty or covered in grime. To clean the screen, always use a soft, clean, antistatic cloth. If any stubborn stains or marks remain, use a non-abrasive glass cleaner applied to a soft, clean cloth. Gently wipe the cloth across the display until the marks have been removed.

Software updates

For the latest information on software updates go to:

www.trwaftermarket.com/easycheck

Specification

TRW easycheck complies with ISO/DIS 15031 Part 4 as an EOBD service tool.

Voltage requirements - 8.0 volts to 16.0 volts DC

Current requirement - 750mA max.

Display - 20 characters by 4 lines LCD with LED back light

Operating Temperature range - 0°C to 50°C

Declaration of Conformity

The TRW easycheck is CE marked and complies with the following directives:

EN55022:1998 - ITE Emissions (Class A)

EN50082-1:1998 - Generic EMC Immunity

EN60950:1992 - Safety Requirements

FCC47 Part 15 - Radio Frequency Devices (Class A)

A copy of the Declaration of Conformity certificate is available on request from the manufacturer or your supplier.

Glossary of terms

Term	Description
J1962	The SAE standard that defines the 16-pin connector used for EOBD
ABS	anti-lock brake system
A/C	air conditioning
AC	air cleaner
AIR	secondary air injection
A/T	automatic transmission or transaxle
SAP	accelerator pedal
B+	battery positive voltage
BARO	barometric pressure
CAC	charge air cooler
CARB	Californian Air Resources Board
CFI	continuous fuel injection
CL	closed loop
CKP	crankshaft position sensor
CKP REF	crankshaft reference
CM	control module
CMP	camshaft position sensor
CMP REF	camshaft reference
CO	carbon monoxide
CO2	carbon dioxide
CPP	clutch pedal position
CTOX	continuous trap oxidizer
CTP	closed throttle position
DEPS	digital engine position sensor
DFCO	decel fuel cut-off mode
DFI	direct fuel injection
DLC	data link connector
DTC	diagnostic trouble code
DTM	diagnostic test mode
EBCM	electronic brake control module
EBTCM	electronic brake traction control module
EC	engine control
ECM	engine control module

Appendix A: Glossary

ECL	engine coolant level
ECT	engine coolant temperature
EEPROM	electrically erasable programmable read only memory
EFE	early fuel evaporation
EGR	exhaust gas re-circulation
EGRT	EGR temperature
EI	electronic ignition
EM	engine modification
EOBD	European On-Board Diagnostics
EPROM	erasable programmable read only memory
EVAP	evaporative emission system
FC	fan control
FEEPROM	flash electrically erasable programmable read only memory
FF	flexible fuel
FP	fuel pump
FPROM	flash erasable programmable read only memory
FT	fuel trim
FTP	federal test procedure
GCM	governor control module
GEN	generator
GND	ground
H2O	water
HO2S	heated oxygen sensor
HO2S1	upstream heated oxygen sensor
HO2S2	up or downstream heated oxygen sensor
HO2S3	downstream heated oxygen sensor
HC	hydrocarbon
HVS	high voltage switch
HVAC	heating ventilation and air conditioning system
IA	intake air
IAC	idle air control
IAT	intake air temperature
IC	ignition control circuit
ICM	ignition control module
IFI	indirect fuel injection

IFS	inertia fuel shut-off
I/M	inspection/maintenance
IPC	instrument panel cluster
ISC	idle speed control
KOEC	key on, engine cranking
KOEO	key on, engine off
KOER	key on, engine running
KS	knock sensor
KSM	knock sensor module
LT	long term fuel trim
MAF	mass airflow sensor
MAP	manifold absolute pressure sensor
MC	mixture control
MDP	manifold differential pressure
MFI	multi-port fuel injection
MI	malfunction indicator lamp
MPH	miles per hour
MST	manifold surface temperature
MVZ	manifold vacuum zone
MY	model year
NVRAM	non-volatile random access memory
NOX	oxides of nitrogen
O2S	oxygen sensor
OBD	on-board diagnostics
OBD I	on-board diagnostics generation one
OBD-II	on-board diagnostics, second generation
OC	oxidation catalyst
ODM	output device monitor
OL	open loop
OSC	oxygen sensor storage
PAIR	pulsed secondary air injection
PCM	powertrain control module
PCV	positive crankcase ventilation
PNP	park/neutral switch
PROM	program read only memory

Appendix A: Glossary

PSA	pressure switch assembly
PSP	power steering pressure
PTOX	periodic trap oxidizer
RAM	random access memory
RM	relay module
ROM	read only memory
RPM	revolutions per minute
SC	supercharger
SCB	supercharger bypass
SDM	sensing diagnostic mode
SFI	sequential fuel injection
SRI	service reminder indicator
SRT	system readiness test
ST	short term fuel trim
TB	throttle body
TBI	throttle body injection
TC	turbocharger
TCC	torque converter clutch
TCM	transmission or transaxle control module
TFP	throttle fluid pressure
TP	throttle position
TPS	throttle position sensor
TVV	thermal vacuum valve
TWC	three way catalyst
TWC+OC	three way + oxidation catalytic converter
VAF	volume airflow
VCM	vehicle control module
VR	voltage regulator
VS	vehicle sensor
VSS	vehicle speed sensor
WU-TWC	warm up three way catalytic converter
WOT	wide open throttle

Appendix B: Cables

Cable identification

Standard cables

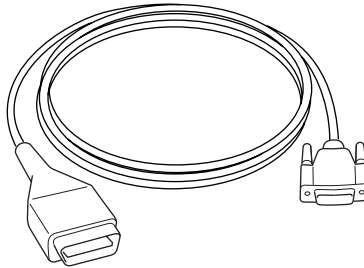

OM0965

*YTD950 - EOBD cable (supplied with TRW easycheck)
required for vehicles with CAN variable service reset.*

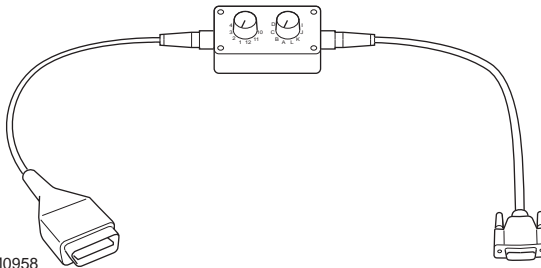

OM0958

*YTD951 - EOBD pin-switchable cable
(supplied with TRW easycheck)*

Optional cables

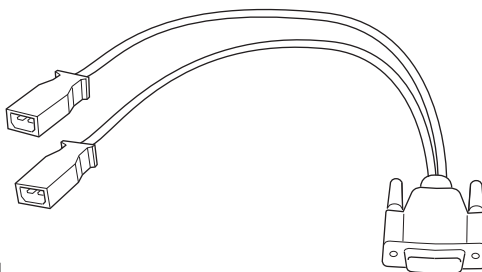

OM0961

YTD952 - VAG cable (optional)

OM0964

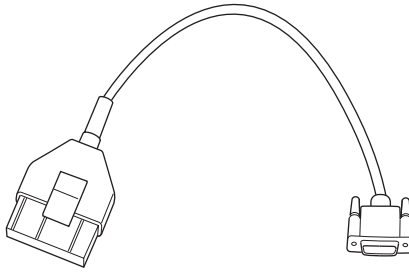

YTD953 – PSA cable (optional)

OM0962

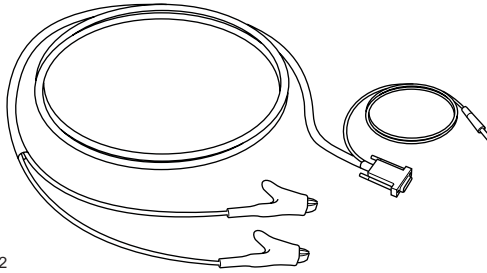

YTD954 - Mercedes flying lead (optional)

OM0963

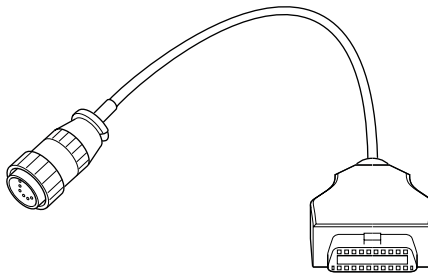

YTD955 – Sprinter cable (optional)

Appendix B: Cables

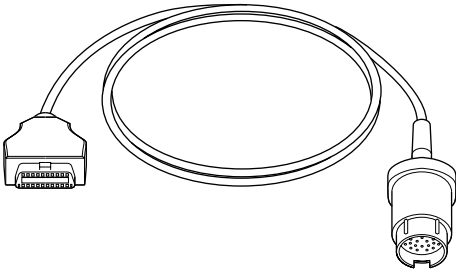

OM0960

YTD956 – Mercedes cable (optional)

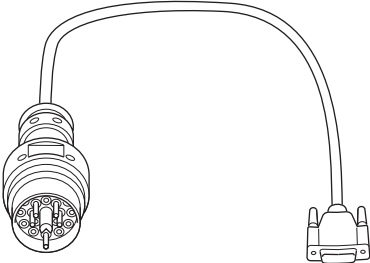

OM0959

YTD957 – BMW cable (optional)

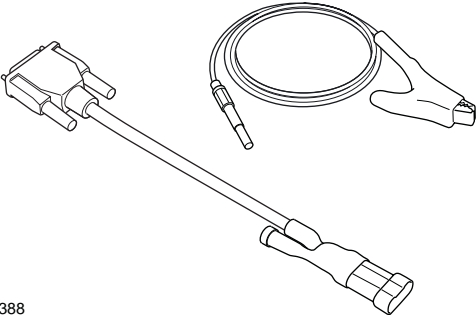

OM1388

YTD958 - Fiat/Alfa Romeo/Lancia (optional)

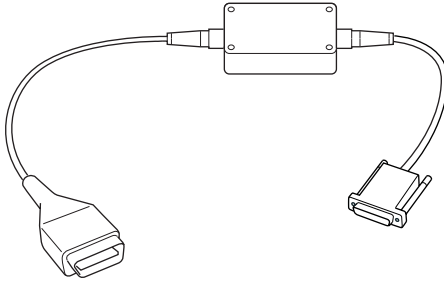

OM1106

YTD959 - Fiat/Alfa Romeo/Lancia (LS CAN) (optional)

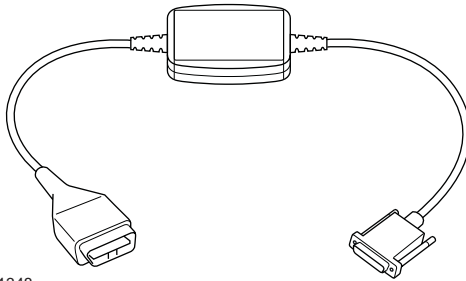

OM1348

YTD960 - CAN converter cable (optional)

Appendix C: Manufacturer compatibility

Scan function

The service tool can communicate with any EOBD compliant vehicle fitted with a J1962 diagnostic socket. The following should be used as a guide.

- All petrol engine vehicles manufactured since 2000.
- All diesel engine vehicles manufactured since 2004.

NOTE: Some manufacturers began incorporating On-Board Diagnostic systems as early as 1994, however not all are 100% compliant.

FastCheck functions

The FastCheck functions currently support the following vehicle manufacturers.

	ABS	Airbag	Climate	EPB	SAS	Service
Alfa Romeo	X	X	X			X
Audi	X	X	X	X	X	X
BMW	X	X	X		X	X
Citroen	X	X	X			
Fiat	X	X	X			X
Ford	X	X	X	X		
GM Opel / Vauxhall	X	X	X			X
Lancia	X	X	X			X
Land Rover	X	X	X			
Mercedes	X	X	X			X
MG Rover		X				X
Mini	X	X	X			X
Peugeot	X	X	X			
Renault	X	X	X	X		
Saab						X
Seat	X	X	X		X	X
Skoda	X	X	X		X	X
Volkswagen	X	X	X	X	X	X
Volvo						X

Refer to the supplied 'Vehicle Application List' on the CD-ROM to determine if a particular vehicle model is supported.

NOTE: If a particular model is not listed, and the vehicle has been manufactured since 2000, it may be possible to connect to the system via the vehicle's J1962 diagnostic socket.

Service Reminder Indicator (SRI)

On some older vehicles it is not possible to reset the SRI by using the service tool. The manufacturers of these vehicles generally have bespoke service reset tools specifically for this task. However on a number of vehicles, it is possible to reset the SRI via interfaces built into the vehicle. The following are some of the most common SRI manual reset procedures.

Alfa Romeo

(1994 - 2000)

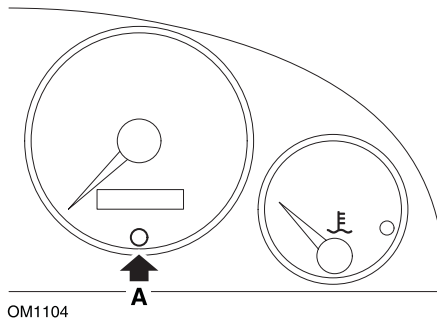

1. Turn the ignition key to OFF.
2. Press button A and keep it pressed.
3. Turn the ignition key to ON.
4. Keep button A pressed for about 10 seconds.
5. The display will show '0' and the spanner symbol will disappear.

Alfa Romeo 156

1. Switch the Ignition ON.
2. Press the (INFO) button on the dashboard to enter the dashboard functions menu.
3. Use the (+) and (-) buttons on the dashboard to navigate to the SERVICE option and press (INFO) to select.
4. Hold down both the (+) and (-) buttons for at least 10 seconds.
5. The 'Number of Miles to Service' should now be reset to approximately 12500 miles.
6. Use the (+) and (-) buttons on the dashboard to navigate to the END MENU option and press (MODE) to exit the functions menu.
7. Switch ignition OFF.

Appendix D: Manual service reset

Audi

Audi A4 and A6 (1995 - 1999)

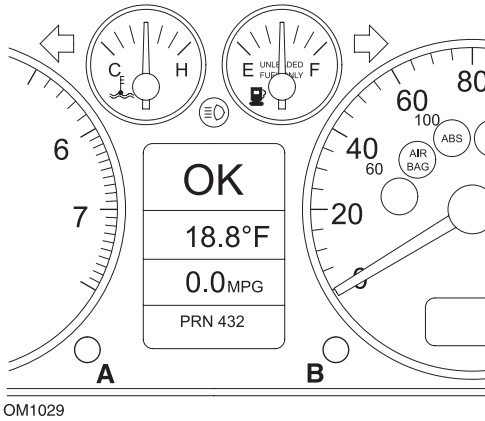

1. With the ignition switch in the OFF position, press and hold button **A** whilst turning the key to the ON position.
2. The message 'Service OIL' will appear. If the message does not display, repeat step 1.
3. Pull out the button **B** until the message is extinguished.
4. The display should now show 'Service ---', indicating that the SRI has been reset.

BMW

BMW 3 Series (E46), BMW 7 Series (E38), BMW 5 Series (E39) and BMW X5 (E53)

BMW X3 (E83) and BMW Z4 (E85)

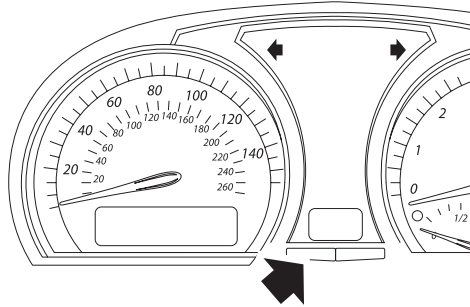
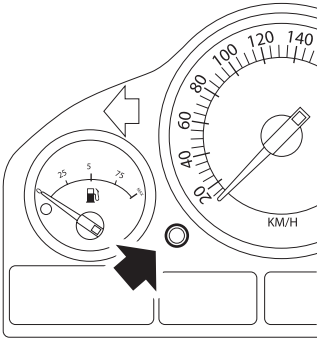

OM1347s

*Button **A** arrowed in illustrations*

The Service Interval Display (SIA) can be reset using the reset button for the trip distance recorder on the instrument cluster

NOTE: The distance-based inspection can only be reset if approximately 10 litres of fuel have been used since the previous reset was performed. The time-based inspection can only be reset if approximately 20 days have passed since the previous reset was performed

1. Switch ignition OFF.
2. Press and hold button **A**.
3. Keep button depressed and switch the ignition to position I.
4. Keep button depressed for 5 seconds, until the service status is displayed.
5. The display will now indicate the remaining distance to service and the type of service required ('OIL SERVICE' or 'INSPECTION'). If the remaining distance is displayed with 'rSt' then the service interval can be reset.
6. To reset the distance to service limit press button **A** for 5 seconds. The 'rSt' (or reset) will flash on the display. If the reset is not required then wait until the 'rSt' (or reset) has stopped flashing before continuing. To reset press button **A** again before 'rSt' has flashed 5 times to reset the service distance limit. The new distance to service will be displayed for 5 seconds.

Appendix D: Manual service reset

NOTE: For vehicles that do not include time-based inspection then 'End SIA' will be displayed with the remaining distance until the next service. For vehicles that do include time-based inspection then the time-based inspection status will be shown.

7. The display will now indicate the remaining time to service. If the remaining time is displayed with 'rSt' then the service interval can be reset.
8. To reset the time to service limit press button **A** for 5 seconds. The 'rSt' (or reset) will flash on the display. If the reset is not required then wait until the 'rSt' (or reset) has stopped flashing before continuing. To reset press button **A** again before 'rSt' has flashed 5 times to reset the service time limit. The new time to service will be displayed for 5 seconds.
9. The 'End SIA' will now be displayed with the remaining time until the next service.

Citroen

Berlingo 1999 - 2002

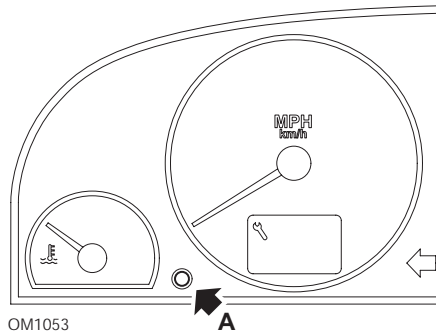

1. Switch ignition OFF.
2. Press and hold button **A**.
3. Switch ignition ON.
4. Keep button depressed for 10 seconds.
The display will now read '0' and the spanner icon will extinguish.

Berlingo 2002 onwards

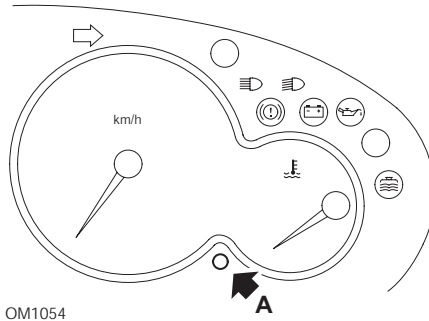

1. Switch ignition OFF.
2. Press and hold button **A**.
3. Switch ignition ON.
4. Keep button depressed for 10 seconds.
The display will now read '0' and the spanner icon will extinguish.

C3

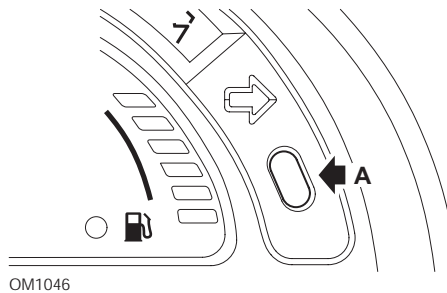

1. Switch ignition OFF.
2. Press and hold button **A**.
3. Switch ignition ON.
4. Keep button depressed until the display reads '0' and the spanner icon extinguishes.

Appendix D: Manual service reset

C5

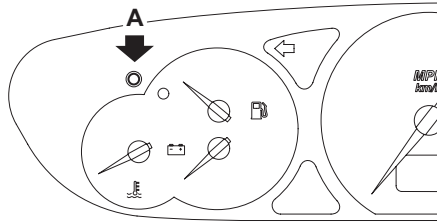

OM1050

1. Switch ignition OFF.
2. Press and hold button **A**.
3. Switch ignition ON.
4. Keep button depressed for 10 seconds.
The display will now read '0' and the spanner icon will extinguish.

C8

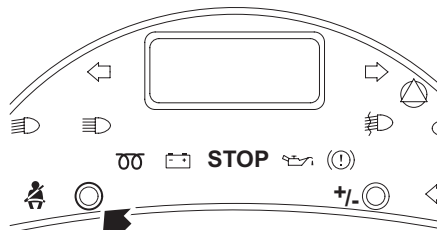

OM1052

1. Switch ignition OFF.
2. Press and hold button **A**.
3. Switch ignition ON.
4. Keep button depressed until the display reads '0' and the spanner icon extinguishes.

Dispatch/Jumpy

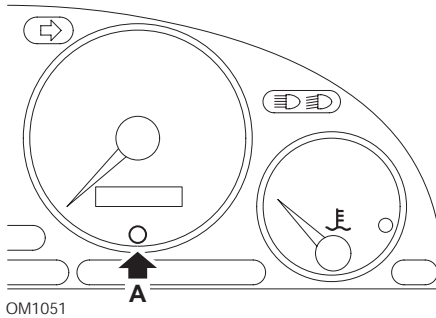

1. Switch ignition OFF.
2. Press and hold button **A**.
3. Switch ignition ON.
4. Keep button depressed for 10 seconds.
The display will now read '0' and the spanner icon will extinguish.

Relay II/Jumper II (2002 onwards)

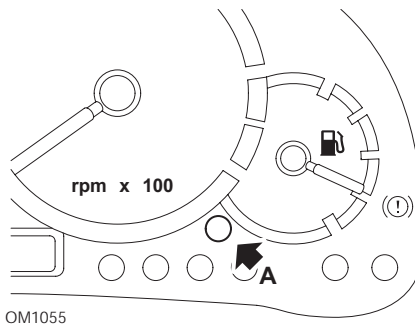

1. Switch ignition OFF.
2. Press and hold button **A**.
3. Switch ignition ON.
4. Keep button depressed for 10 seconds.
The display will now read '0' and the spanner icon will extinguish.

Appendix D: Manual service reset

Saxo

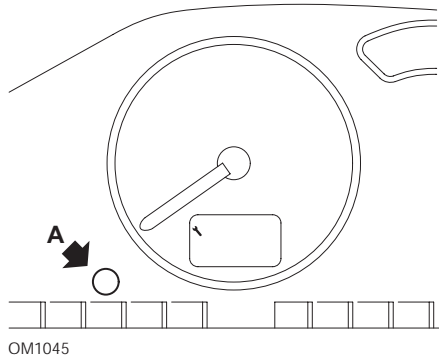

1. Switch ignition OFF.
2. Press and hold button **A**.
3. Switch ignition ON.
4. Keep button depressed for 10 seconds.
The display will now read '0' and the spanner icon will extinguish.

Synergie/Evasion

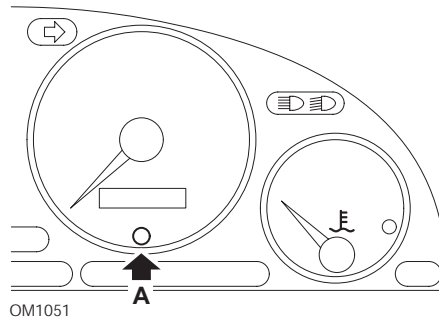

1. Switch ignition OFF.
2. Press and hold button **A**.
3. Switch ignition ON.
4. Keep button depressed for 10 seconds.
The display will now read '0' and the spanner icon will extinguish.

Xantia

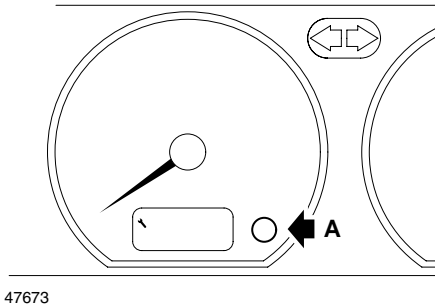

1. Switch ignition OFF.
2. Press and hold button **A**.
3. Switch ignition ON.
4. Keep button depressed. The spanner icon and the service interval will illuminate for 5 seconds, then extinguish.

Xsara (1997 - 2000)

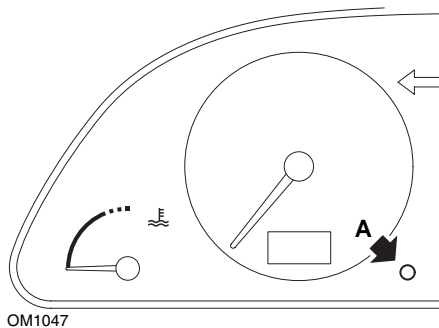

1. Switch ignition OFF.
2. Press and hold button **A**.
3. Switch ignition ON.
4. Keep button depressed. The spanner icon and the service interval will illuminate for 5 seconds, then extinguish.

Appendix D: Manual service reset

Xsara (2000 onwards)

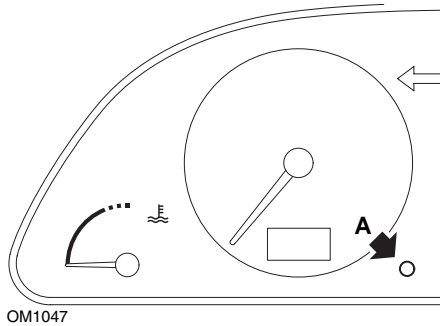

1. Switch ignition OFF.
2. Press and hold button **A**.
3. Switch ignition ON.
4. Keep button depressed for 10 seconds.
The display will now read '0' and the spanner icon will extinguish.

Xsara Picasso

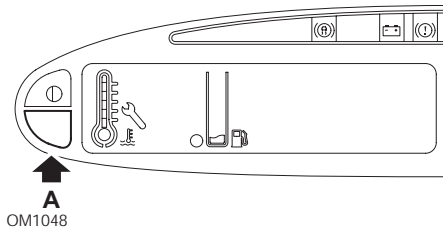

1. Switch ignition OFF.
2. Press and hold button **A**.
3. Switch ignition ON.
4. Keep button depressed for 10 seconds.
The display will now read '0' and the spanner icon will extinguish.

Fiat

(1994 - 2000)

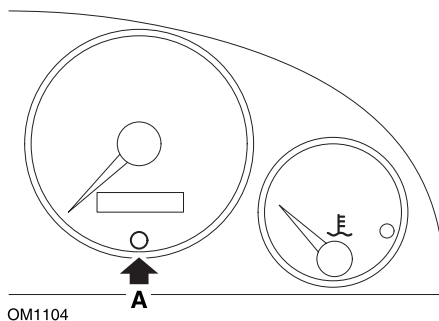

1. Turn the ignition key to OFF.
2. Press button A and keep it pressed.
3. Turn the ignition key to ON.
4. Keep button A pressed for about 10 seconds.
5. The display will show '0' and the spanner symbol will disappear.

Appendix D: Manual service reset

GM Vauxhall/Opel

Omega-B, Vectra-B 1999 onwards

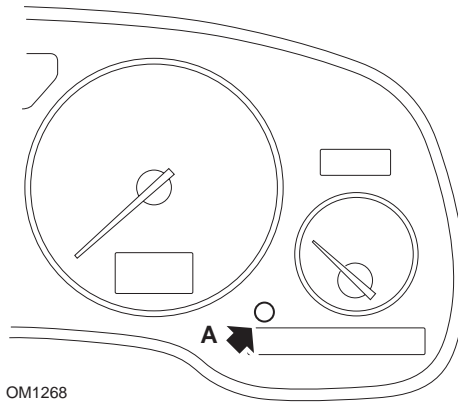

1. Switch ignition OFF.
2. Press and hold button **A**.
3. Switch ignition ON.
4. Keep button depressed until three dashes are displayed '--- --- ---'.
5. Switch ignition OFF to check the service request has been cleared.

Lancia

(1994 - 2000)

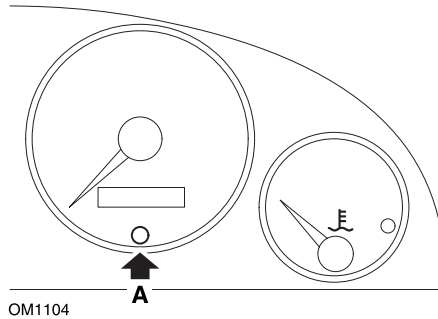

1. Turn the ignition key to OFF.
2. Press button **A** and keep it pressed.
3. Turn the ignition key to ON.
4. Keep button **A** pressed for about 10 seconds.
5. The display will show '0' and the spanner symbol will disappear.

Appendix D: Manual service reset

Land Rover

Range Rover III 2002 onwards (all except Japan and NAS)

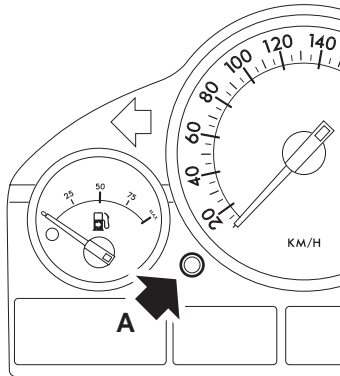









OM1257

1. Switch ignition OFF.
2. Press and hold button **A**.
3. Keep button depressed and switch the ignition to position I.
4. Keep button depressed for 5 seconds, until the 'SIA RESET' appears.
5. The display will now indicate the distance to service and the type of service required (OIL SERVICE or INSPECTION).
6. Check the distance to service has been reached.
 - a. If yes, proceed to step 9
 - b. If no, proceed to next step
7. Press button **A** once. The display will show the date to service.
8. Check the service date has been reached.
 - a. If yes, proceed to step 11
 - b. If no, proceed to step 10
9. When the distance to service limit has been reached, press button **A** for 5 seconds. 'RESET' will flash on the display. Press button **A** again before 'RESET' has flashed 5 times to reset the service distance limit. The new distance to service will be displayed for 5 seconds before the service date is displayed.
10. Press button **A** once to end the service interval check and reset.
11. When the date for service limit has been reached, press and hold button **A** for 5 seconds. 'RESET' will flash on the display. Press button **A** again before 'RESET' has flashed 5 times to reset the service date limit. The new date to service will be displayed for 5 seconds before end service is displayed.
12. Switch ignition OFF.

Mercedes

Mercedes (1998 - 2007)

With the Flexible Service System and multi-function steering wheel controls

1. Switch ignition ON.
2. Use buttons  and  to scroll through the multi-function display until the trip odometer and main odometer readings are displayed, or in the case of a separate main odometer display, scroll until the exterior temperature is displayed.
3. Use buttons  and  to scroll through the multifunction display until the service indicator  or  is displayed.
4. Press and hold button  on the instrument cluster for approximately 3 seconds, until the following question is displayed within the multifunction display:
'DO YOU WANT TO RESET SERVICE INTERVAL? CONFIRM BY PRESSING R'
or
'SERVICE INTERVAL? RESET WITH R BUTTON FOR 3 SEC'
5. Press and hold button  on the instrument cluster again, until a signal sounds.
6. The new service interval will appear in the multifunction display.
NOTE: The  refers to the trip distance reset button.

Mercedes (1998 - 2002)

With the Flexible Service System and without multi-function steering wheel controls

1. Turn the ignition switch to the ON position and then immediately press the button next to the digital display twice within one second.
The current status for days or distance will be displayed.
2. Turn the ignition switch to the OFF position within 10 seconds.
3. Press and hold the button while turning the ignition switch to the ON position.
The status for days or distance will be displayed again.
4. After approximately 10 seconds you will hear a confirmation chime and the display will show '10,000 miles' ('15,000 km'). Release the button.

Appendix D: Manual service reset

Peugeot

106

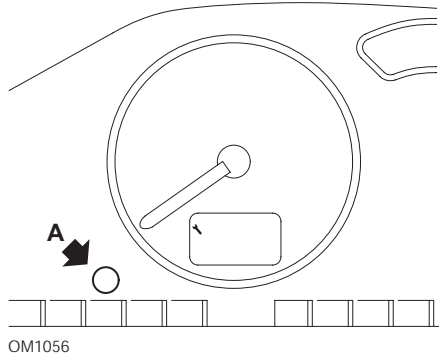

1. Switch ignition OFF.
2. Press and hold button **A**.
3. Switch ignition ON.
4. Keep button depressed for 10 seconds.
The display will now read '0' and the spanner icon will extinguish.

206

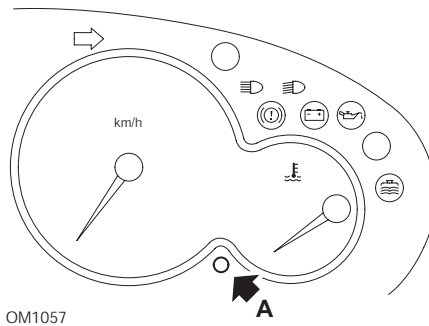

1. Switch ignition OFF.
2. Press and hold button **A**.
3. Switch ignition ON.
4. Keep button depressed for 10 seconds.
The display will now read '0' and the spanner icon will extinguish.

306

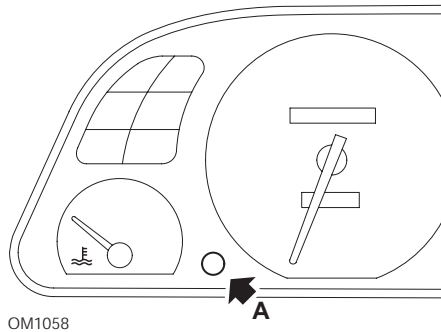

1. Switch ignition OFF.
2. Press and hold button **A**.
3. Switch ignition ON.
4. Keep button depressed for 10 seconds.
The display will now read '0' and the spanner icon will extinguish.

307

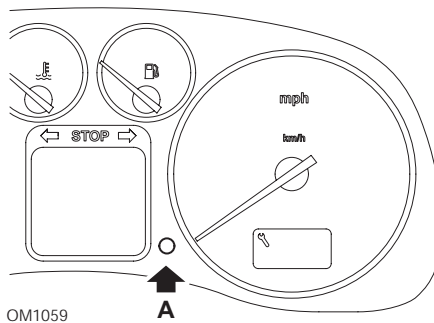

1. Switch ignition OFF.
2. Press and hold button **A**.
3. Switch ignition ON.
4. Keep button depressed for 10 seconds.
The display will now read '0' and the spanner icon will extinguish.

Appendix D: Manual service reset

406

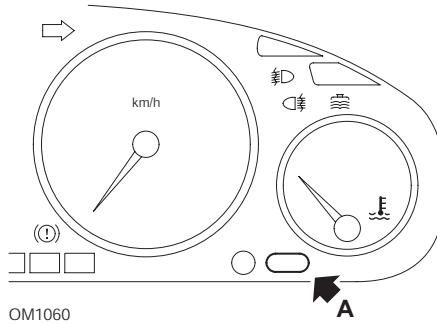

1. Switch ignition OFF.
2. Press and hold button **A**.
3. Switch ignition ON.
4. Keep button depressed for 10 seconds.
The display will now read '0' and the spanner icon will extinguish.

607

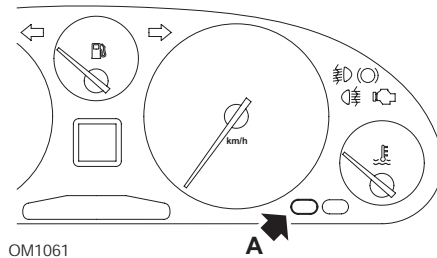

1. Switch ignition OFF.
2. Press and hold button **A**.
3. Switch ignition ON.
4. Keep button depressed for 10 seconds.
The display will now read '0' and the spanner icon will extinguish.

806

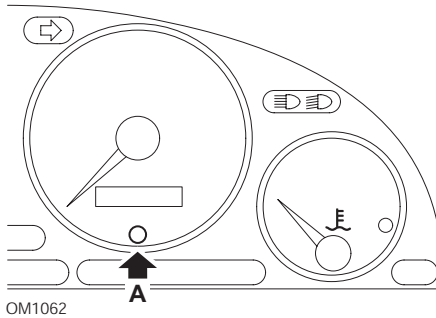

1. Switch ignition OFF.
2. Press and hold button **A**.
3. Switch ignition ON.
4. Keep button depressed for 10 seconds.
The display will now read '0' and the spanner icon will extinguish.

807

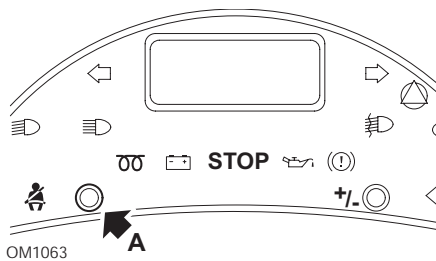

1. Switch ignition OFF.
2. Press and hold button **A**.
3. Switch ignition ON.
4. Keep button depressed until the display reads '0' and the spanner icon extinguishes.

Appendix D: Manual service reset

Boxer II 2002 onwards

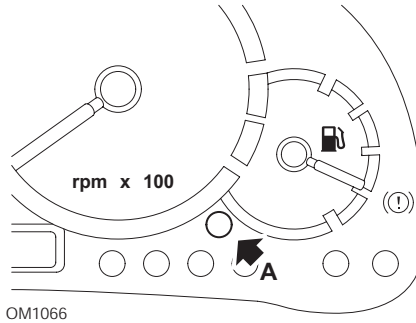

1. Switch ignition OFF.
2. Press and hold button **A**.
3. Switch ignition ON.
4. Keep button depressed for 10 seconds.
The display will now read '0' and the spanner icon will extinguish.

Expert

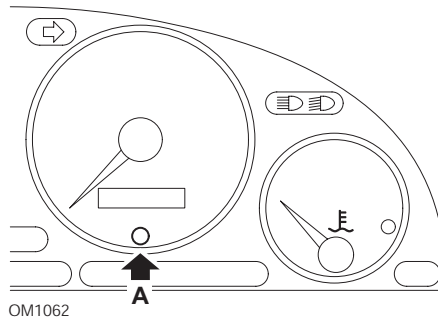

1. Switch ignition OFF.
2. Press and hold button **A**.
3. Switch ignition ON.
4. Keep button depressed for 10 seconds.
The display will now read '0' and the spanner icon will extinguish.

Partner 1999 - 2002

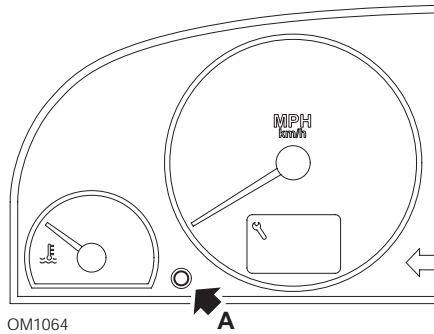

1. Switch ignition OFF.
2. Press and hold button **A**.
3. Switch ignition ON.
4. Keep button depressed for 10 seconds.
The display will now read '0' and the spanner icon will extinguish.

Partner 2002 onwards

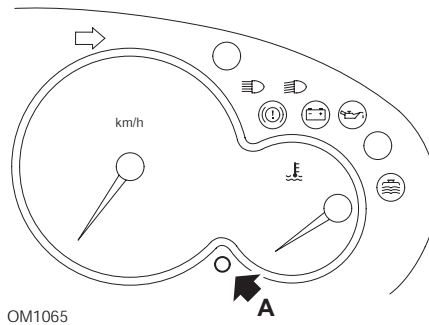

1. Switch ignition OFF.
2. Press and hold button **A**.
3. Switch ignition ON.
4. Keep button depressed for 10 seconds.
The display will now read '0' and the spanner icon will extinguish.

Appendix D: Manual service reset

Renault Oil level

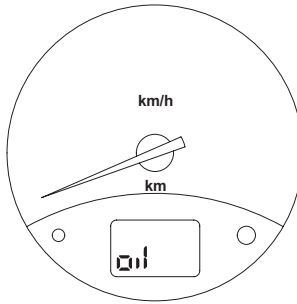

OM1067

The lamp illustrated is an oil level low warning indicator and not a service interval indicator. When the engine oil is at the correct level, this lamp will automatically extinguish.

Malfunction Indicator Lamp (MIL)

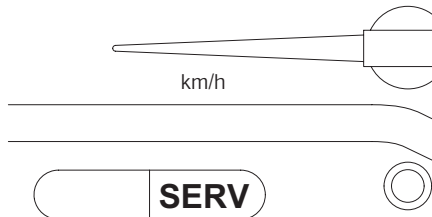

OM1068

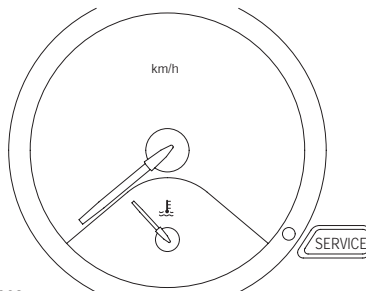

OM1069

The lamps illustrated above, are Malfunction Indicator Lamps (MIL) and not service interval indicators. When illuminated there is a problem with the vehicle. Refer to manufacturer's documentation for further information.

Appendix D: Manual service reset

Clio III (models with trip computer; 2006 onwards)

Scenic II (models with trip computer; 2003 onwards)

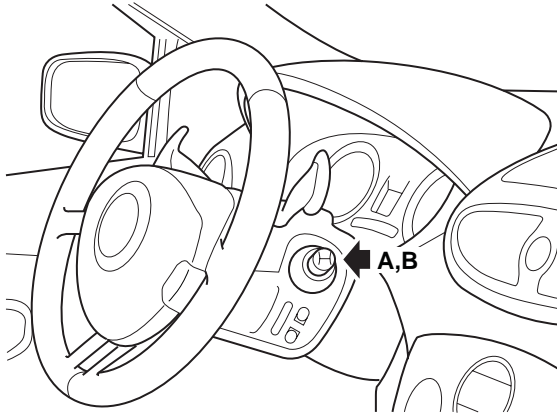

OM1384

1. Switch ignition ON.
2. Press and release display reset button **A** or **B** on the tip of the wiper lever until the 'Distance Before Next Service' information is displayed.
3. Continue to depress the button for 10 seconds until the display shows the distance to next service permanently. The indicator will then show the appropriate service interval (e.g. 6000 miles/10000 km).
4. Release the reset button.
5. Switch ignition OFF.

Appendix D: Manual service reset

Laguna (models with trip computer; 1994 - 1998)

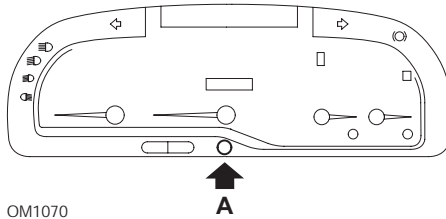

1. Switch ignition ON.
2. Press reset button **A** until spanner icon flashes.
3. Continue to depress the button until the spanner icon stops flashing and remains illuminated.
The indicator will show the appropriate service interval (e.g. '6000 miles'/'10000 km').
4. Release the reset button.
5. Switch ignition OFF.

Laguna II (2001 onwards)

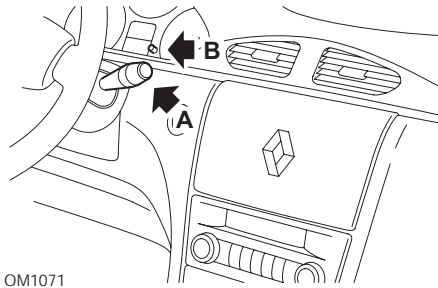

1. Switch ignition ON.
2. Repeatedly press reset button **A** until spanner icon flashes and the distance remaining until the next service appears in the odometer display.
3. Press and hold button **B** until the display has flashed 8 times.
4. Release button **B**. The new service interval is now displayed.
5. Switch ignition OFF.

Megane II (models with trip computer; 2003 onwards)

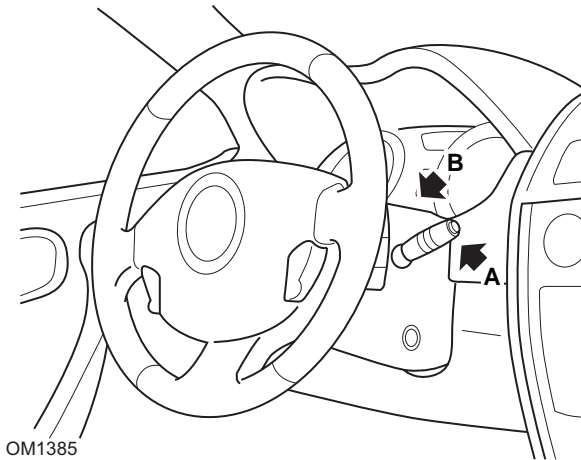

1. Switch ignition ON.
2. Press and release display reset button **A** on the tip of the wiper lever until the service information is displayed.
3. Press button **B** for 10 seconds until the display shows the next service interval permanently. The indicator will then show the appropriate distance before the next service (e.g. '6000 miles'/'10000 km').
4. Release the reset button.
5. Switch ignition OFF.

Appendix D: Manual service reset

Safrane

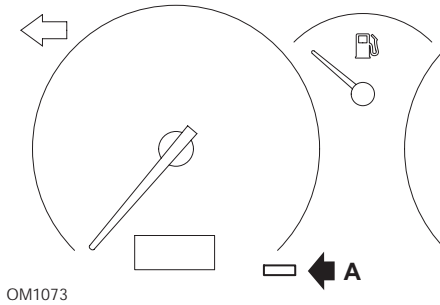

1. Press and hold button **A**.
2. Switch ignition ON.
3. Continue to depress the button until the spanner icon stops flashing and remains illuminated.
The indicator will show the appropriate service interval (e.g. '6000 miles' / '10000 km').
4. Release the reset button.
5. Switch ignition OFF.

Vel Satis

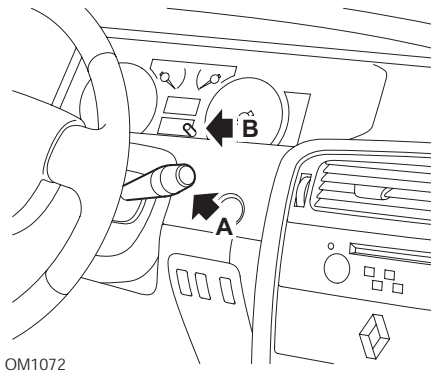

1. Switch ignition ON.
2. Repeatedly press reset button **A** until spanner icon flashes and the distance remaining until the next service appears in the odometer display.
3. Press and hold button **B** until the display has flashed 8 times.

4. Release button **B**. The new service interval is now displayed.
5. Switch ignition OFF.

Smart

Roadster

Service Type	Symbol
Service A	One Spanner Displayed
Service B	Two Spanners Displayed

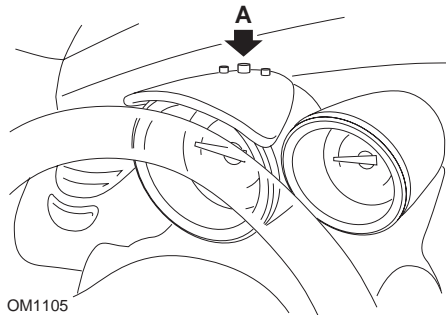

1. Turn the ignition ON and within 4 seconds select the service interval display by pressing button **A** on the top of the instrument cluster (repeatedly until the service interval is displayed).
2. Hold button **A** down and turn the ignition OFF.
3. Turn the ignition ON.
4. With button **A** held down turn the ignition ON and wait for 10 seconds. The service indicator will now be reset.
5. Release button **A**, the type and distance to the next service will be shown.

Appendix D: Manual service reset

Volkswagen

Cabrio, Golf III, GTi, Jetta III (1993 - 1995) and Jetta (1996)

One of four service codes may be displayed on instrument panel according to distance travelled. Each service code displayed determines the type or level of maintenance required. The service code will flash for approximately 3 seconds in odometer display window as the ignition is turned on. When servicing becomes due (every 7,500 miles), the appropriate service code will flash for approximately 60 seconds. The four service codes available for display are as follows:

- IN 00 (No Service Necessary)
- OEL (Oil Change Service) - Every 7,500 Miles
- IN 01 (Inspection Service) - Every 15,000 Miles
- IN 02 (Additional Servicing Work) - Every 30,000 Miles

After performing the required maintenance, each effected service code displayed must be reset individually. For example, at 15,000 miles service codes OEL and IN 01 will both need to be reset.

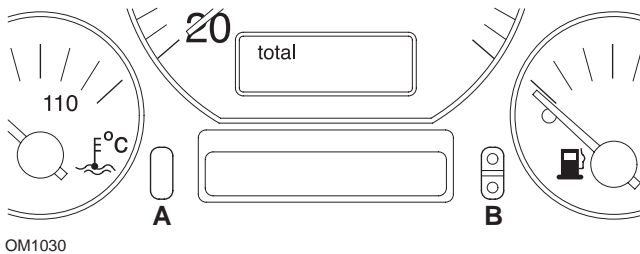

1. To reset the SRI, turn the ignition switch to the ON position. Press and hold the odometer reset button **A**. Whilst holding button A, turn the ignition switch to the OFF position.
2. Service code 'OEL' will be displayed. To reset this counter, press and hold button **B** until 5 dashes appear on the display.
3. If necessary, press the button A to display 'IN 01'. To reset this counter, press and hold button **B** until 5 dashes appear on the display.
4. If necessary, press the button A to display 'IN 02'. To reset this counter, press and hold button **B** until 5 dashes appear on the display.
5. To exit reset mode, turn the ignition switch to the ON position.
6. When 'IN 00' is displayed, turn the ignition switch to the OFF position.

Volvo

Volvo 240 (1986 - 1989)

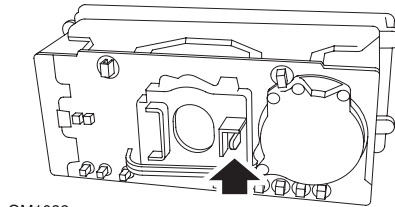
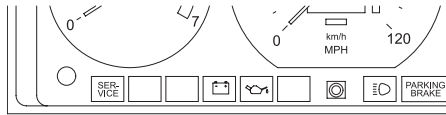

OM1032

Reach behind the instrument panel and push the lever located between the tachometer and the speedometer.

Volvo 240 (1990 - 1993)

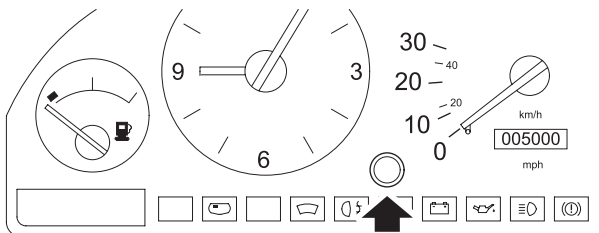

OM1033

1. Remove the plug from the face of the instrument panel between the clock and the speedometer.
2. Insert a thin-bladed tool into the cavity and press the reset button.

Appendix D: Manual service reset

Volvo 740 (1986 - 1988)

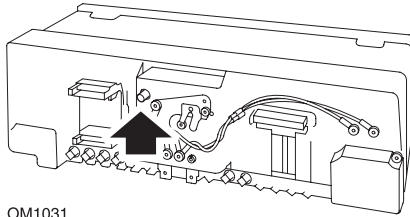
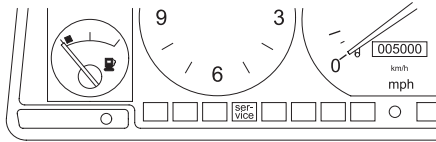

OM1031

Reach behind the instrument panel and push the button located to the left of the speedometer.

Volvo 740 (1989 - 1992)

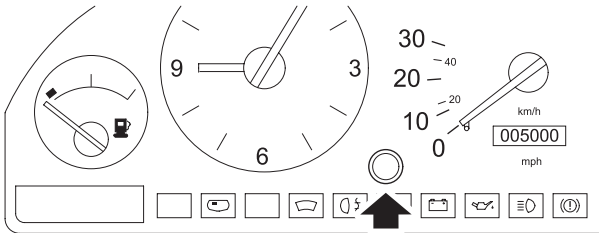

OM1033

1. Remove the plug from the face of the instrument panel between the clock and the speedometer.
2. Insert a thin-bladed tool into the cavity and press the reset button.

Appendix D: Manual service reset

Volvo 760 (1986 - 1990)

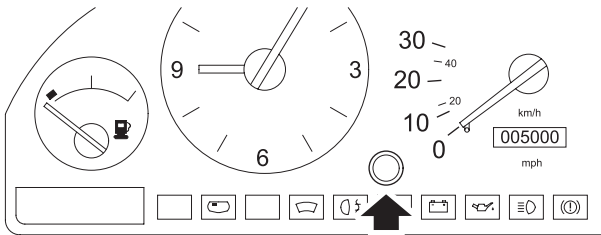

OM1033

1. Remove the plug from the face of the instrument panel between the clock and the speedometer.
2. Insert a thin-bladed tool into the cavity and press the reset button.

Volvo 780 (1988 - 1990)

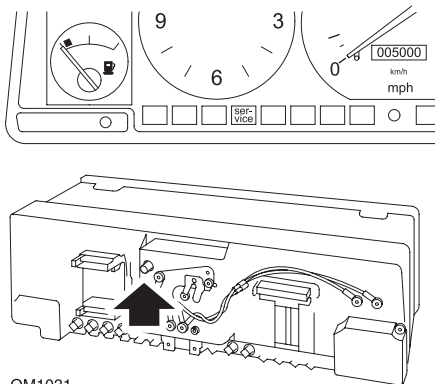

OM1031

Reach behind the instrument panel and push the button located to the left of the speedometer.

Appendix D: Manual service reset

Volvo 850 (1993 - 1995) fitted with the Yazaki instrument panel

NOTE: This instrument panel has the odometer located above the speedometer needle.

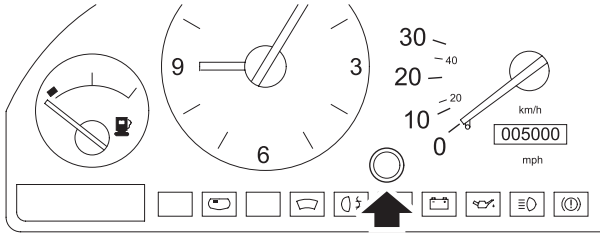

OM1033

1. Remove the plug from the face of the instrument panel between the clock and the speedometer.
2. Insert a thin-bladed tool into the cavity and press the reset button.

Volvo 850 (1993 - 1995) fitted with the VDO instrument panel

NOTE: This instrument panel has the odometer located below the speedometer needle.

1. With the ignition switch in the ON position and the engine not running.

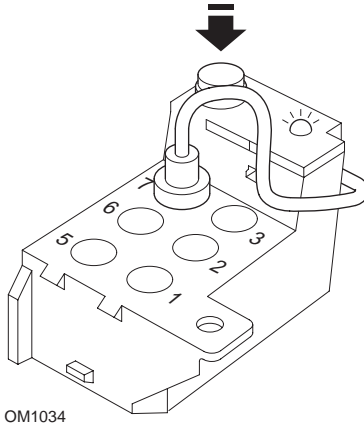

Diagnostic module located in engine compartment adjacent to LH suspension mount

2. Connect the diagnostic module test lead to terminal 7.
3. Press the reset button on the diagnostic module 4 times in quick succession.
4. When the LED on the diagnostic unit illuminates and stays illuminated, press the reset button once and release it.
5. When the LED illuminates and stays illuminated, press the button 5 times in quick succession.
6. When the LED illuminates again, press the button once.
7. The LED will flash several times to indicate that the sequence has been correctly entered and the SRI has been reset.
8. Unplug the test lead from terminal 7 and turn the ignition switch to the OFF position.

Appendix D: Manual service reset

Volvo 940 (1991 - 1995)

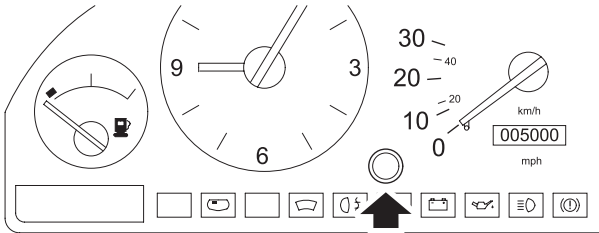

OM1033

1. Remove the plug from the face of the instrument panel between the clock and the speedometer.
2. Insert a thin-bladed tool into the cavity and press the reset button.

Volvo 960 (1991 - 1995)

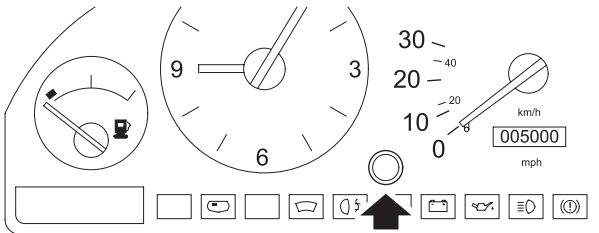

OM1033

1. Remove the plug from the face of the instrument panel between the clock and the speedometer.
2. Insert a thin-bladed tool into the cavity and press the reset button.

